

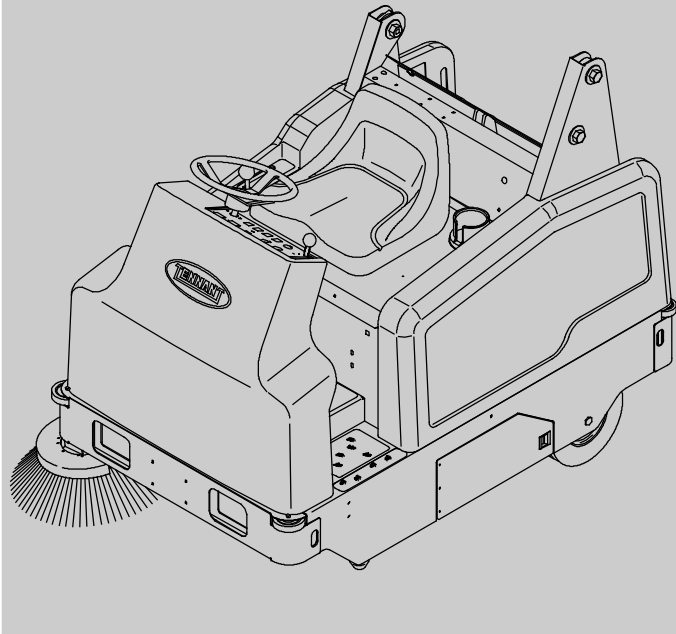

6200

(Battery)

Rider Sweeper Operator Manual



VCS[®] Filter Shaker
TennantTrue[®] Parts
IRIS[®] a Tennant Technology

North America / International



For the latest Parts manuals and other
language Operator manuals, visit:

www.tennantco.com/manuals

330410
Rev. 16 (12-2015)



INTRODUCTION

This manual is furnished with each new model. It provides necessary operation and maintenance instructions.



Read this manual completely and understand the machine before operating or servicing it.

This machine will provide excellent service. However, the best results will be obtained at minimum costs if:

- The machine is operated with reasonable care.
- The machine is maintained regularly - per the machine maintenance instructions provided.
- The machine is maintained with manufacturer supplied or equivalent parts.

| PROTECT THE ENVIRONMENT | MACHINE DATA |
|---|---|
| | Please fill out at time of installation for future reference. |
| Please dispose of packaging materials, used components such as batteries and fluids in an environmentally safe way according to local waste disposal regulations. | Model No. - _____ |
| | Serial No. - _____ |
| Always remember to recycle. | Installation Date - _____ |
| | |

INTENDED USE

The 6200 is an industrial rider machine designed to sweep hard surfaces (concrete, asphalt, stone, synthetic, etc). Typical applications include industrial warehouses, manufacturing facilities, distribution facilities, stadiums, arenas, convention centers, parking facilities, transportation terminals, and construction sites. Do not use this machine on soil, grass, artificial turf, or carpeted surfaces. This machine can be used both indoors and outdoors, but ensure there is adequate ventilation if used indoors. This machine is not intended for use on public roadways. Do not use this machine other than described in this Operator Manual.

Tennant Company

PO Box 1452

Minneapolis, MN 55440

Phone: (800) 553- 8033 or (763) 513- 2850

www.tennantco.com

Quick Mop, VCS, Instant Access filter, and Thermo Sentry are trademarks of Tennant Company.

HydroLink is a registered trademark of Trojan® Battery Company.

Specifications and parts are subject to change without notice.

Original instructions. Copyright © 1999- 2003, 2005- 2008, 2010, 2012, 2013, 2015 TENNANT, Printed in U.S.A.

CONTENTS

| | Page | | Page |
|--|------|--|------|
| SAFETY PRECAUTIONS | 3 | MAINTENANCE | 44 |
| OPERATION | 6 | MAINTENANCE CHART | 44 |
| OPERATOR RESPONSIBILITY | 6 | LUBRICATION | 46 |
| MACHINE COMPONENTS | 7 | STEERING GEAR CHAIN | 46 |
| SYMBOL DEFINITIONS | 8 | STEERING CASTOR PIVOT BEARING | 46 |
| CONTROLS AND INSTRUMENTS | 9 | HYDRAULICS | 47 |
| OPERATION OF CONTROLS | 10 | HYDRAULIC FLUID RESERVOIR | 47 |
| DIRECTIONAL PEDAL | 10 | HYDRAULIC FLUID | 48 |
| BRAKE PEDAL | 11 | HYDRAULIC HOSES | 48 |
| PARKING BRAKE PEDAL (For machines below serial number 003468) | 11 | BATTERIES | 49 |
| PARKING BRAKE (For machines serial number 003468 and above) | 11 | CHECKING THE ELECTROLYTE LEVEL | 49 |
| LARGE DEBRIS TRAP PEDAL | 11 | MAINTENANCE- FREE BATTERIES .. | 50 |
| MAIN BRUSH LEVER | 12 | CHECKING CONNECTIONS / CLEANING | 50 |
| VACUUM FAN AND FILTER SHAKER SWITCH | 12 | CHARGING THE BATTERIES | 50 |
| POWER KILL SWITCH (OPTION) | 12 | HYDROLINK® BATTERY WATERING SYSTEM (OPTION) | 52 |
| BATTERY DISCHARGE INDICATOR .. | 13 | BELTS AND CHAINS | 54 |
| STEERING WHEEL | 13 | VACUUM FAN BELT | 54 |
| HOURMETER | 13 | MAIN BRUSH BELT | 54 |
| ON- OFF KEY SWITCH | 14 | STEERING GEAR CHAIN | 55 |
| HORN BUTTON | 14 | STATIC DRAG CHAIN | 55 |
| SIDE BRUSH LEVER | 14 | DEBRIS HOPPER | 56 |
| OPERATING LIGHTS SWITCH (OPTION) | 14 | HOPPER DUST FILTER | 56 |
| OPERATING/HAZARD LIGHTS SWITCH (OPTION) | 15 | REMOVING HOPPER DUST FILTER | 57 |
| HOPPER SWITCH | 15 | THERMO SENTRY | 60 |
| HOPPER DOOR SWITCH | 15 | BRUSHES | 61 |
| FUSES | 16 | MAIN BRUSH | 61 |
| CIRCUIT BREAKERS | 16 | REPLACING MAIN BRUSH | 61 |
| OPERATOR SEAT | 17 | CHECKING AND ADJUSTING MAIN BRUSH PATTERN | 62 |
| ADJUSTABLE OPERATOR SEAT (OPTION) | 17 | SIDE BRUSH | 64 |
| DELUXE SUSPENSION SEAT (OPTION) | 18 | REPLACING SIDE BRUSH | 65 |
| HOPPER SUPPORT BAR | 18 | SIDE BRUSH GUARD | 65 |
| HOW THE MACHINE WORKS | 19 | SKIRTS AND SEALS | 66 |
| PRE-OPERATION CHECKLIST | 19 | SIDE SKIRTS | 66 |
| STARTING THE MACHINE | 20 | LARGE DEBRIS TRAP SKIRT | 66 |
| SWEEPING AND BRUSH INFORMATION .. | 21 | SIDE RECIRCULATION SKIRTS | 66 |
| SWEEPING | 23 | REAR SKIRTS | 67 |
| STOP SWEEPING | 25 | HOPPER SEALS | 68 |
| EMPTYING THE HOPPER | 26 | HOPPER DOOR SEAL | 68 |
| STOPPING THE MACHINE | 28 | HOPPER LIP SEAL | 68 |
| POST-OPERATION CHECKLIST | 29 | VACUUM SEAL | 69 |
| ENGAGING HOPPER SUPPORT BAR .. | 30 | HOPPER FILTER SEALS | 69 |
| DISENGAGING HOPPER SUPPORT BAR .. | 32 | BRAKES AND TIRES | 70 |
| OPERATION ON INCLINES | 33 | BRAKES | 70 |
| OPTIONS | 34 | TIRES | 71 |
| VACUUM WAND | 34 | ELECTRIC MOTORS | 71 |
| QUICK MOP | 36 | PUSHING, TOWING, AND TRANSPORTING THE MACHINE | 72 |
| ROLLOUT BATTERY | 38 | PUSHING OR TOWING THE MACHINE .. | 72 |
| MACHINE TROUBLESHOOTING | 43 | TRANSPORTING THE MACHINE | 72 |
| | | MACHINE JACKING | 74 |
| | | STORING MACHINE | 74 |

CONTENTS

| | Page |
|---|------|
| SPECIFICATIONS | 75 |
| GENERAL MACHINE PERFORMANCE .. | 75 |
| POWER TYPE | 76 |
| STEERING | 76 |
| HYDRAULIC SYSTEM | 76 |
| BRAKING SYSTEM (For machines serial number 003467 and below) | 76 |
| TIRES | 76 |
| MACHINE DIMENSIONS | 77 |
| INDEX | 78 |

SAFETY PRECAUTIONS

The following symbols are used throughout this manual as indicated in their description:



WARNING: To warn of hazards or unsafe practices that could result in severe personal injury or death.

FOR SAFETY: To identify actions that must be followed for safe operation of equipment.

The following information signals potentially dangerous conditions to the operator. Know when these conditions can exist. Locate all safety devices on the machine. Report machine damage or faulty operation immediately.



WARNING: Batteries emit hydrogen gas. Explosion or fire can result. Keep sparks and open flame away. Keep covers open when charging.



WARNING: Lift arm pinch point. Stay clear of hopper lift arms.



WARNING: Raised hopper may fall. Engage hopper support bar

WARNING: This machine contains chemicals known to the state of California to cause cancer, birth defects, or other reproductive harm.

This machine may be equipped with technology that automatically communicates over the cellular network. If this machine will be operated where cell phone use is restricted because of concerns related to equipment interference, please contact a Tennant representative for information on how to disable the cellular communication functionality.

FOR SAFETY:

1. **Do not operate machine:**
 - Unless trained and authorized.
 - Unless operation manual is read and understood.
 - Under the influence of alcohol or drugs.
 - While using a cell phone or other types of electronic devices.
 - Unless mentally and physically capable of following machine instructions.
 - If it is not in proper operating condition.
 - Without filters in place.
 - Without dust bags and filters in place.

- With brake disabled.
- In areas where flammable vapors/liquids or combustible dusts are present.
- In areas that are too dark to safely see the controls or operate the machine unless operating / headlights are turned on.
- In areas with possible falling objects unless equipped with overhead guard.

2. Before starting machine:

- Check machine for fluid leaks.
- Make sure all safety devices are in place and operate properly.
- Check brakes and steering for proper operation.
- Adjust seat and fasten seat belt. (if equipped).

3. When starting machine:

- Keep foot on brake and directional pedal in neutral.

4. When using machine:

- Use only as described in this manual.
- Do not pickup burning or smoking debris, such as cigarettes, matches, or hot ashes.
- Use brakes to stop machine.
- Go slowly on inclines and slippery surfaces.
- Reduce speed when turning.
- Keep all parts of body inside operator station while machine is moving.
- Always be aware of surroundings while operating machine.
- Use care when reversing machine.
- Make sure adequate clearance is available before raising hopper.
- Move machine with care if hopper is raised.
- Do not raise hopper when machine is on an incline.
- Keep children and unauthorized persons away from machine.
- Do not carry passengers on any part of the machine.
- Always follow safety and traffic rules.
- Report machine damage or faulty operation immediately.

5. Before leaving or servicing machine:

- Stop on level surface.
- Set parking brake.
- Turn off machine and remove key.

SAFETY PRECAUTIONS

6. When servicing machine:

- All work must be done with sufficient lighting and visibility.
- Keep work area well ventilated.
- Avoid moving parts. Do not wear loose clothing, jewelry and secure long hair.
- Block machine tires before jacking up machine.
- Do not push or tow the machine on inclines with the brake disabled.
- Jack up machine at designated locations only. Block machine up with jack stands.
- Use hoist or jack that will support the weight of the machine.
- Do not push or tow the machine without an operator in the seat controlling the machine.
- Do not power spray or hose off machine near electrical components.
- Wear eye and ear protection if using pressurized air or water.
- Avoid contact with battery acid.
- Disconnect battery connections and charger cord before working on machine.
- Keep all metal objects off batteries.
- Use a non-conductive battery removal device.
- Use a hoist or adequate assistance when lifting batteries.
- Battery installation must be done by trained personnel.
- Follow site safety guidelines concerning battery removal.
- All repairs must be performed by trained personnel.
- Do not modify the machine from its original design.
- Use cardboard to locate leaking hydraulic fluid under pressure.
- Use Tennant supplied or equivalent replacement parts.
- Do not disconnect the off-board charger's DC cord from the machine receptacle when the charger is operating. Arcing may result. If the charger must be interrupted during charging, disconnect the AC power supply cord first..
- Do not use incompatible battery chargers as this may damage battery packs and potentially cause a fire hazard.
- Inspect charger cord regularly for damage.

7. When loading/unloading machine onto/off truck or trailer:

- Empty debris hopper before loading machine.
- Turn off machine and remove key.
- Use ramp, truck or trailer that will support the weight of the machine and operator.
- Use winch. Do not drive the machine onto/off the truck or trailer unless the load height is 380 mm (15 in) or less from the ground.
- Set parking brake after machine is loaded.
- Block machine tires.
- Tie machine down to truck or trailer.

The following safety labels are mounted on the machine in the locations indicated. If these or any labels become damaged or illegible, install a new label in its place.



FOR SAFETY LABEL - LOCATED ON THE SIDE OF THE OPERATOR COMPARTMENT.



HOPPER SUPPORT LABEL - LOCATED ON LEFT SIDE HOPPER LIFT ARM AND BOTH SIDES OF THE HOPPER COMPARTMENT

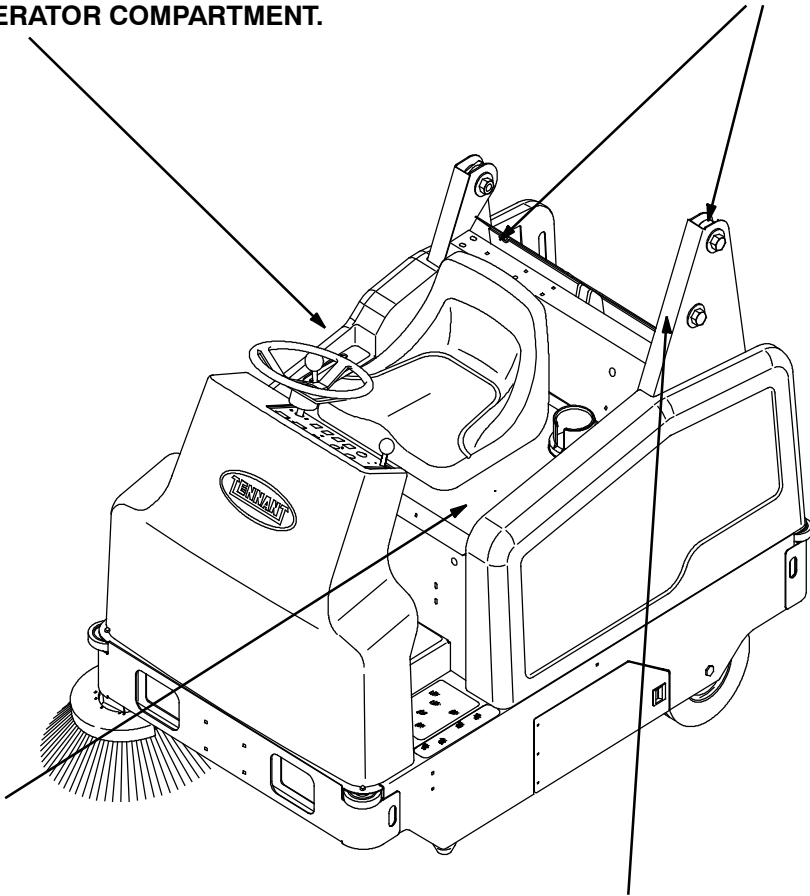

BATTERY CHARGING LABEL - LOCATED IN BATTERY COMPARTMENT AND ON SEAT MOUNTING WELDMENT.



HOPPER LIFT ARMS LABEL - LOCATED ON BOTH LIFT ARMS.

OPERATOR RESPONSIBILITY

- The operator's responsibility is to take care of the daily maintenance and checkups of the machine to keep it in good working condition. The operator must inform the service mechanic or supervisor when the maintenance intervals are required as stated in the *MAINTENANCE* section of this manual.

- Read this manual carefully before operating the machine. View the operation video supplied with the machine.

FOR SAFETY: Do not operate machine, unless operation manual is read and understood.

- Check the machine for shipping damage. Check to make sure the machine is complete per shipping instructions.
- Keep your machine regularly maintained by following the maintenance information in this manual. We recommend taking advantage of a regularly scheduled service contract from your Tennant representative.
- Order parts and supplies directly from your authorized Tennant representative. Use the parts manual provided when ordering parts.
- After operation, follow the recommended daily and hourly procedures stated in the *MAINTENANCE CHART*.

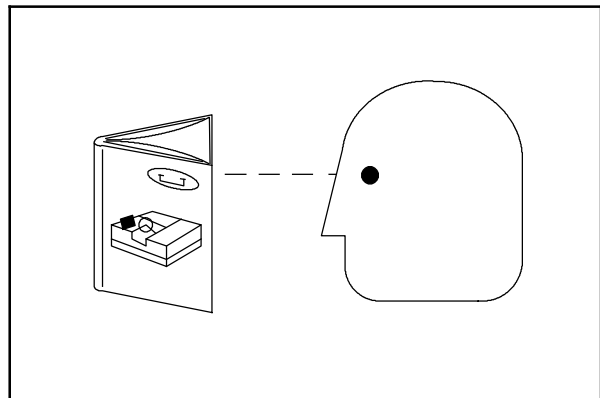

07324

MACHINE COMPONENTS

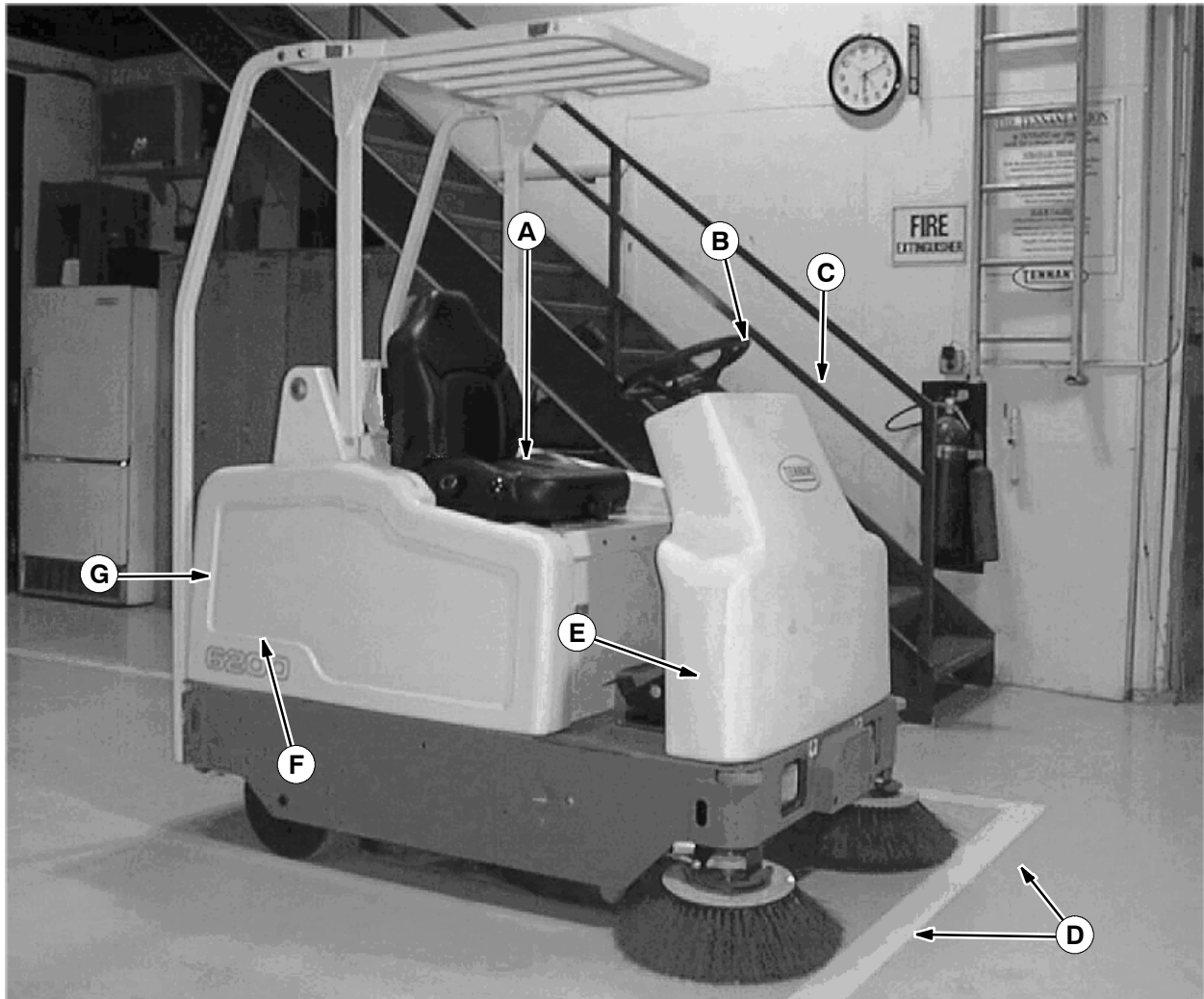

























- A. Operator seat
- B. Steering wheel
- C. Instrument panel
- D. Side brush(es)
- E. Control pedals
- F. Hopper
- G. Hopper filter

OPERATION

SYMBOL DEFINITIONS

These symbols identify controls, displays, and features on the machine:

| | | | |
|---|--------------------|---|------------------------|
|  | On |  | Operating lights |
|  | Off |  | Hazard light |
|  | Main brush down |  | Start |
|  | Main brush up |  | Vacuum Fan |
|  | Circuit breaker #1 |  | Filter shaker |
|  | Circuit breaker #2 |  | Horn |
|  | Circuit breaker #3 |  | Side brush down and on |
|  | Circuit breaker #4 |  | Side brush up and off |
|  | Circuit breaker #5 |  | Hopper lift |
|  | Circuit breaker #6 |  | Hopper lower |
|  | Circuit breaker #7 |  | Open hopper |
|  | Circuit breaker #8 |  | Close hopper |
|  | Circuit breaker #9 | | |

CONTROLS AND INSTRUMENTS

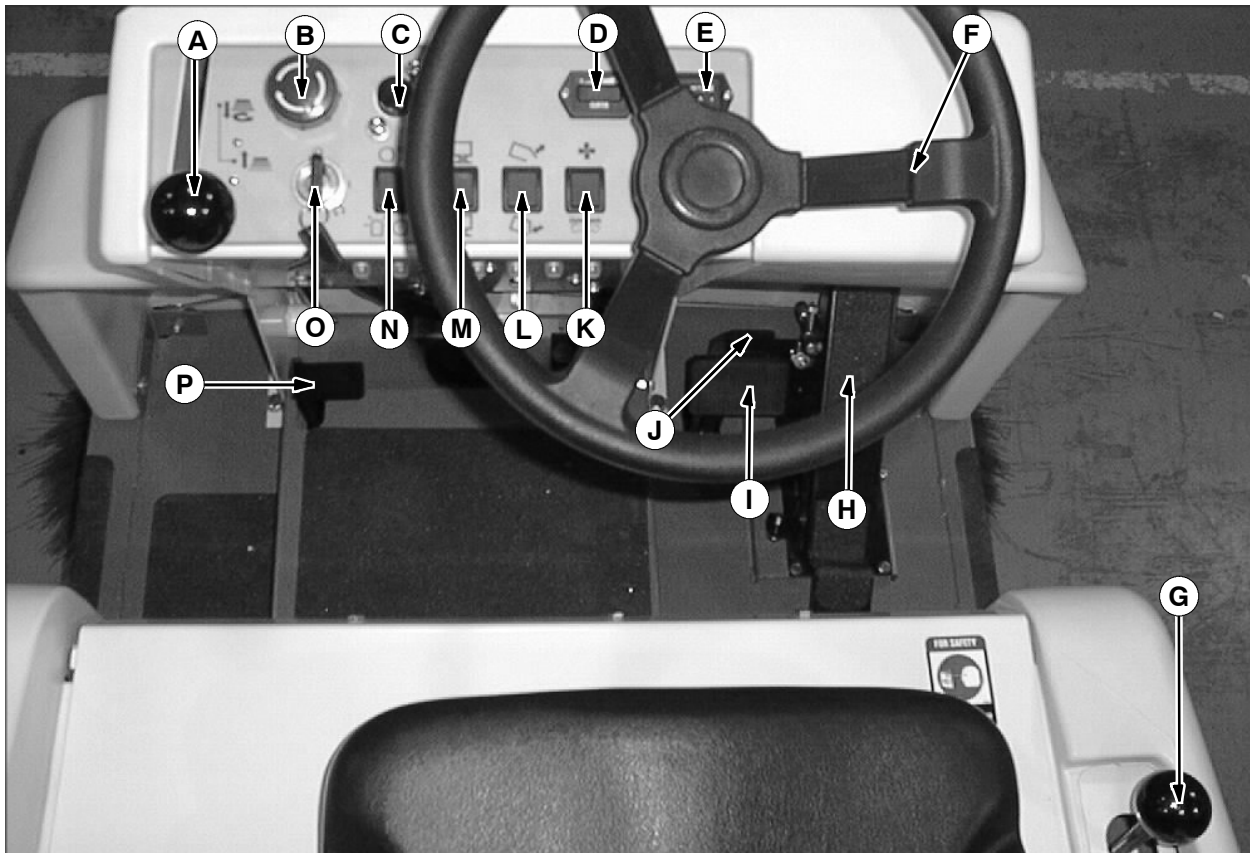

- A. Side brush(es) lever
- B. Power kill switch (option)
- C. Horn
- D. Battery discharge indicator
- E. Hourmeter
- F. Steering wheel
- G. Main brush lever
- H. Directional pedal
- I. Brake pedal
- J. Parking brake pedal (For machines below serial number 003468)
- K. Vacuum fan/filter shaker switch
- L. Hopper door switch
- M. Hopper switch
- N. Operating/Hazard light switch (option)
- O. On/Off key switch
- P. Large debris trap pedal

OPERATION

OPERATION OF CONTROLS

DIRECTIONAL PEDAL

The *directional pedal* controls the direction of travel and the propelling speed of the machine. Change the speed of the machine with the pressure of your foot on the pedal; the harder you press the faster the machine travels.

Use the brake pedal to stop the machine.

Forward: Press the top of the directional pedal with the toe of your foot.

NOTE: The machine will not travel unless the operator is sitting in the operator's seat.

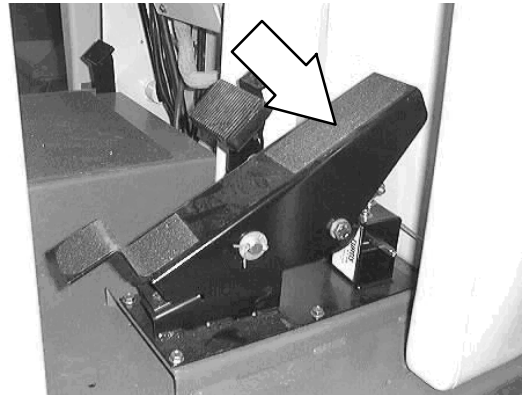

Reverse: Press the bottom of the directional pedal with the heel of your foot.

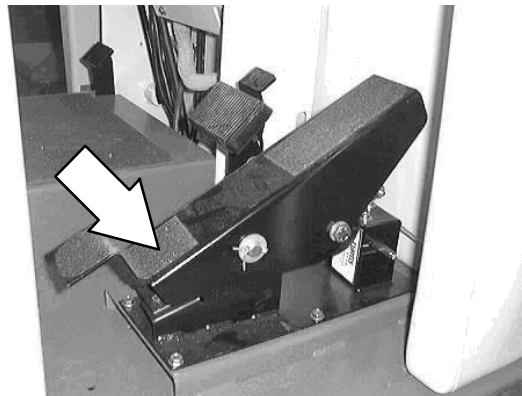

Neutral: Take your foot off the directional pedal and it will return to the **Neutral** position.

NOTE: The machine may coast when the foot is taken off the directional pedal. Be prepared to step on the brake pedal when removing foot from directional pedal.

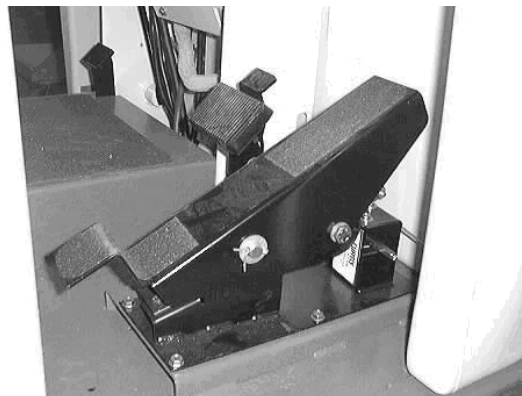

BRAKE PEDAL

The *brake pedal* stops the machine.

Stop: Remove your foot from the directional pedal and let it return to the **Neutral** position. Step on the brake pedal to prevent the machine from rolling.

NOTE: Machine may roll a slight distance when turned off. Keep foot on brake until machine stops moving.

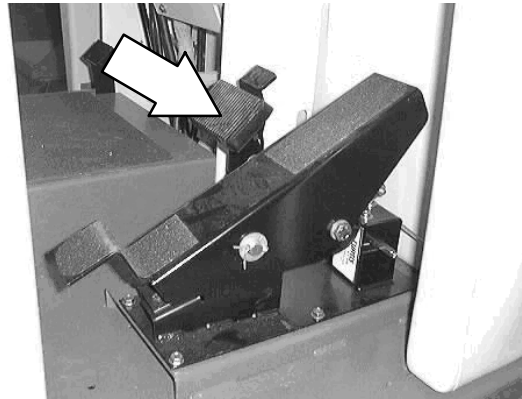
**PARKING BRAKE PEDAL (For machines below serial number 003468)**

The *parking brake pedal* sets and releases the front wheel brake.

Set: Press the brake pedal down as far as possible, then press on the parking brake with the toe portion of your foot to lock the parking brake pedal in place.

FOR SAFETY: Before leaving or servicing machine, stop on level surface, set parking brake, turn off machine, and remove key.

Release: Press down on the brake pedal until the parking brake releases.

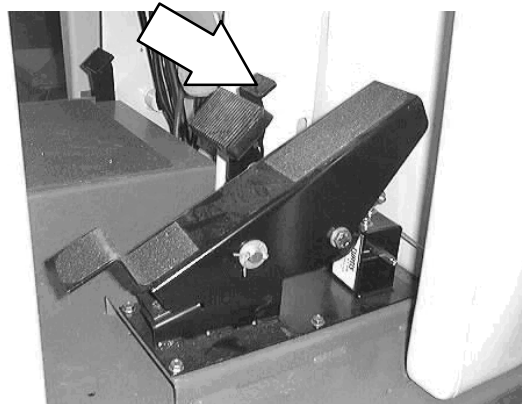
**PARKING BRAKE (For machines serial number 003468 and above)**

The *parking brake* on this machine is automatic and will engage approximately one second after the machine stops.

LARGE DEBRIS TRAP PEDAL

The *large debris trap pedal* opens the large debris flap in front of the main sweeping brush.

Open: Press on the trap pedal when sweeping up larger debris. The flap in front of the main sweeping brush will open to take in large debris.

Close: Release the pedal and the flap will close, trapping larger debris into the hopper.



OPERATION

MAIN BRUSH LEVER

The *main brush lever* controls the position and the power of the main brush.

Main brush down and on: Pull the lever to the right and back into the **Main brush down and on** position. The brush will automatically start rotating.

Main brush up and off: Push the lever up and to the left into the **Main brush up and off** position. The brush will automatically stop rotating.



VACUUM FAN AND FILTER SHAKER SWITCH

The *vacuum fan and filter shaker switch* controls the vacuum fan and the VCS *Vibrating Comb Shaker* system filter shaker.

Vacuum fan on: Press the top of the switch to the **Vacuum fan on** position.

Vacuum fan off: Press the switch to the **middle off** position.

Start VCS system filter shaker: **Press and hold** the bottom of the switch for eight to ten seconds.

NOTE: Excessive heat in the hopper will cause the Thermo Sentry to shut off the vacuum fan. If this happens, stop the machine and eliminate the source of heat. Press the vacuum fan and filter shaker switch to the middle off position, then back to the on position.

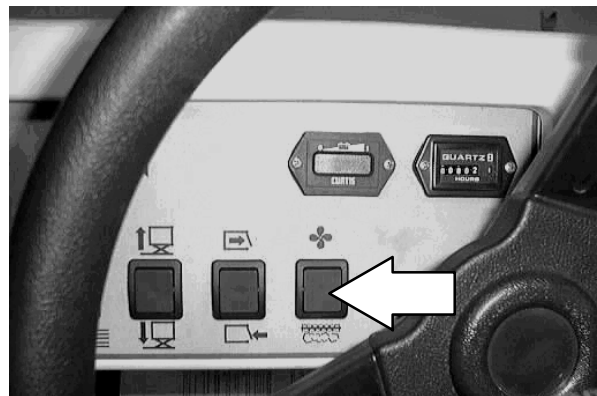

POWER KILL SWITCH (OPTION)

The *power kill switch* halts all power to the machine.

Halt: Push the power kill switch in.

Restart: Turn off the machine power. Turn the power kill switch to the right to release the switch. Turn on the machine power.

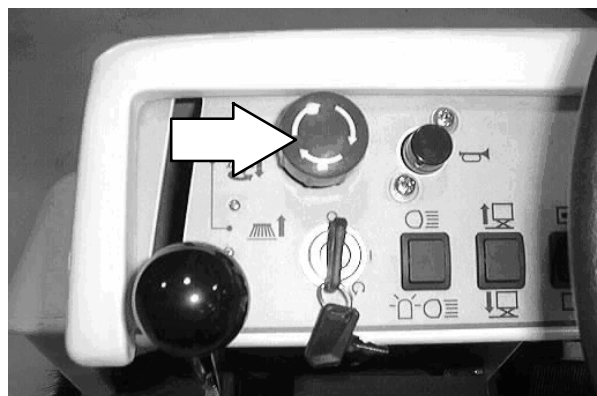

BATTERY DISCHARGE INDICATOR

The *battery discharge indicator* shows the charge level of the batteries. It displays the charge level when the machine is operating.

When the batteries are fully charged, the indicator on the far right is lit. As the batteries discharge, the indicator will move along the display to the left. Recharge the batteries when the indicator flashes.

NOTE: The reading on the battery discharge indicator is not accurate when the machine is first powered on. Operate the machine a few minutes before reading the charge level of the batteries.

NOTE: The battery discharge indicator will not reset from the flashing indicator unless the batteries have been fully charged.

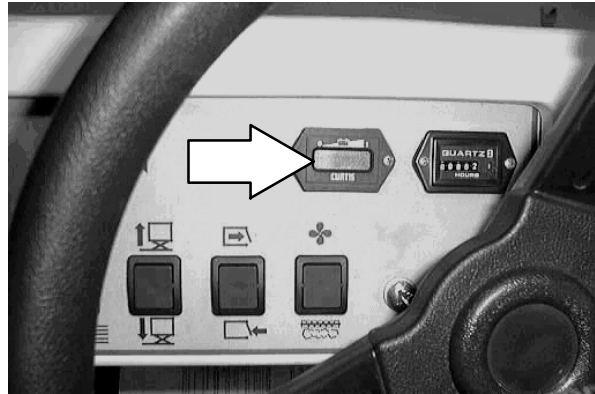

STEERING WHEEL

The *steering wheel* controls the machine's direction. The machine is very responsive to the steering wheel movements.

Left: Turn the steering wheel to the left.

Right: Turn the steering wheel to the right.

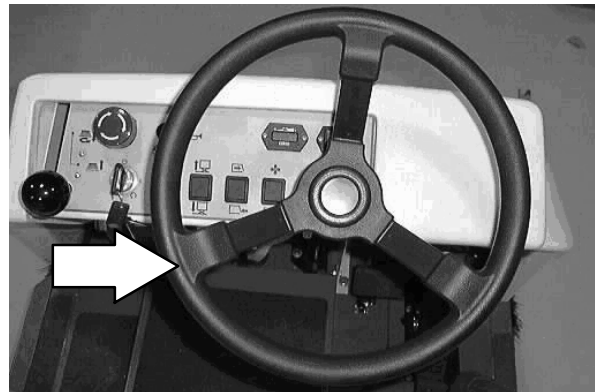

HOURMETER

The *hourmeter* records the number of hours the machine has been operated. The hourmeter displays the number of hours in tenths of an hour. Use this information to determine machine maintenance intervals.

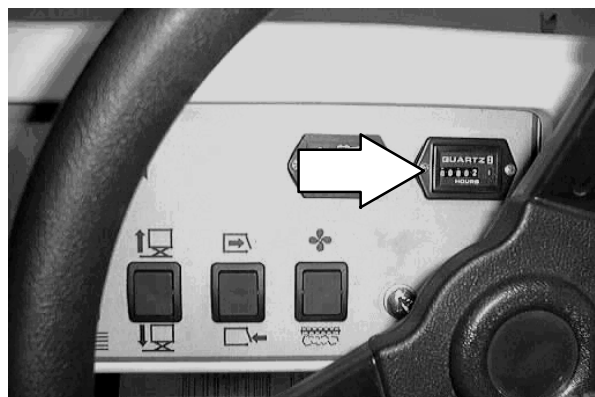

OPERATION

ON - OFF KEY SWITCH

The *on-off key switch* controls machine power with a key.

FOR SAFETY: When starting machine, keep foot on brake and directional pedal in neutral.

On: Turn the key all the way clockwise.

Off: Turn the key counterclockwise.

NOTE: The machine will not travel unless the operator is sitting in the operator's seat.

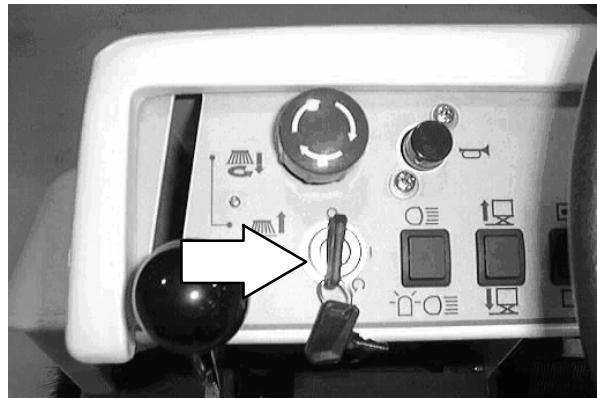

HORN BUTTON

The *horn button* operates the horn.

Sound: Press the button.

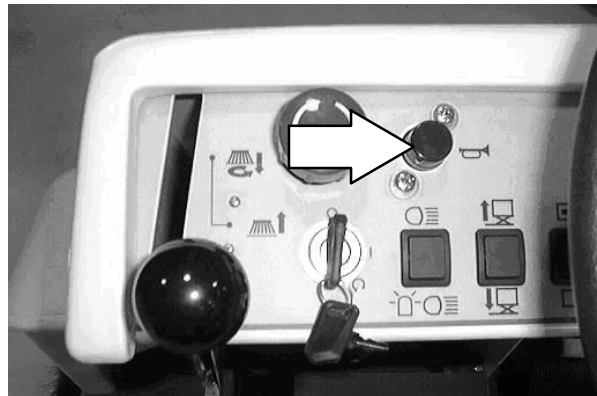

SIDE BRUSH LEVER

The *side brush lever* controls the position and the power of both the right hand side brush and the optional left hand side brush.

Side brush down and on: Pull the lever left and forward into the **Side brush down and on** position. The brush will automatically start rotating.

Side brush up and off: Pull the lever back and to the right into the **Side brush up and off** position.

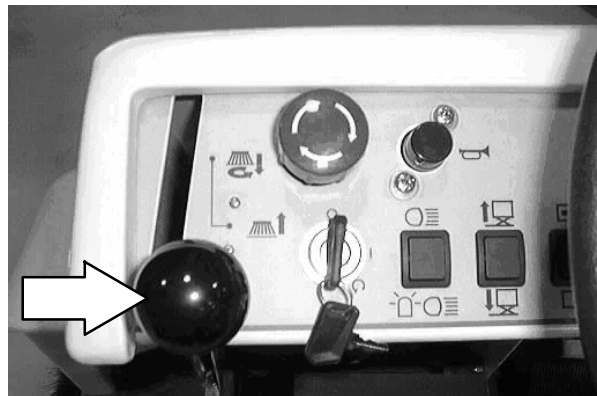

OPERATING LIGHTS SWITCH (OPTION)

The *operating lights switch* powers on and off the headlights and taillights option.

On: Press the top of the operating lights switch.

Off: Press the switch to the middle position.

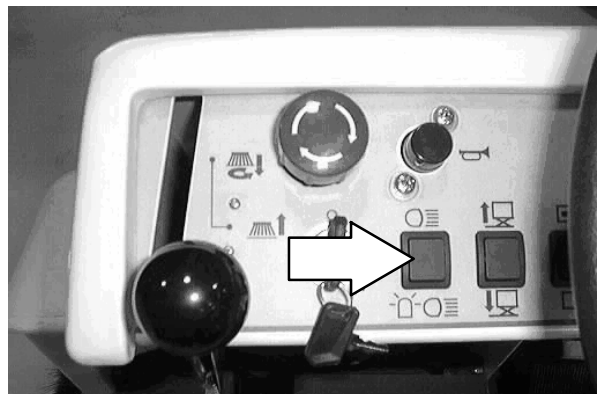

OPERATING/HAZARD LIGHTS SWITCH (OPTION)

The *operating/hazard lights switch* powers on and off the headlights and taillights option and the hazard light option.

Operating lights on: Press the top of the operating/hazard lights switch.

Operating/Hazard lights on: Press the bottom of the operating/hazard lights switch.

Off: Press the operating/hazard lights switch to the middle off position.

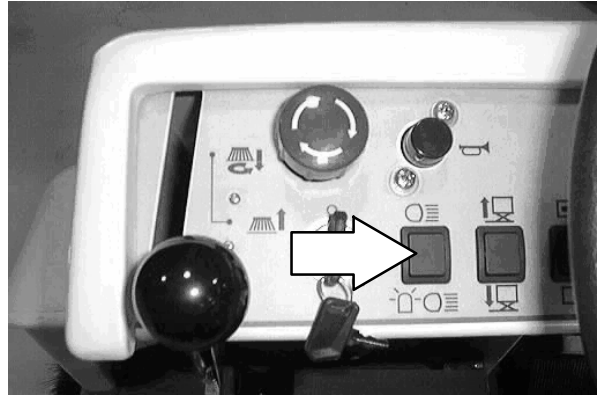

HOPPER SWITCH

The *hopper switch* raises and lowers the hopper.

Raise hopper: **Press and hold** the top of the switch until the hopper is in the desired raised position.

Hold: Release the hopper switch into the middle position.

Lower hopper: **Press and hold** the bottom of the switch until the hopper is in the desired lowered position.

 **WARNING: Brush throws debris. Stop motor before lifting hopper.**

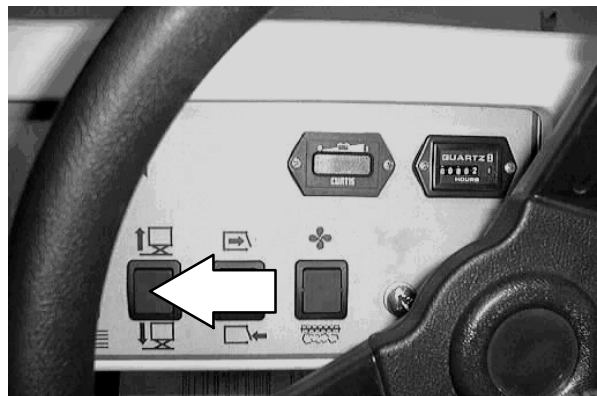

HOPPER DOOR SWITCH

The *hopper door switch* opens and closes the hopper door.

Open hopper door: **Press and hold** the top of the switch until the door is in the desired open position.

Hold: Release the hopper door switch into the middle position.

Close hopper door: **Press and hold** the bottom of the switch until the door is in the desired closed position.

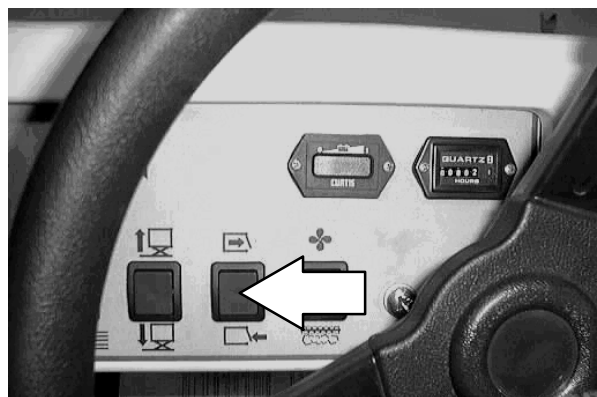

OPERATION

FUSES

Fuses are one-time protection devices designed to stop the flow of current in the event of a circuit overload. Never substitute higher value fuses than specified.

The fuse is located behind the circuit breaker panel.

| Fuse | Rating | Circuit Protected |
|------|--------|-------------------|
| FU-1 | 80 A | Main |

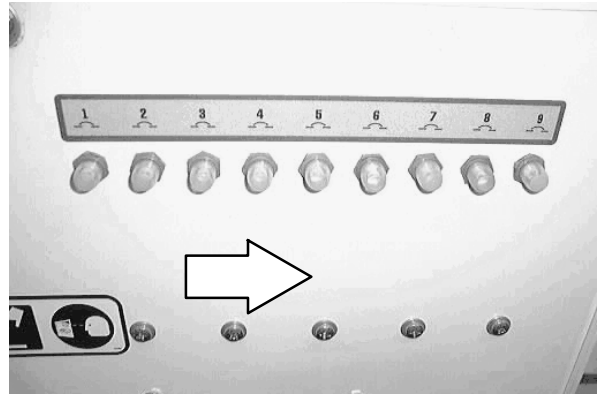

CIRCUIT BREAKERS

The *circuit breakers* are resettable electrical circuit protection devices. Their design stops the flow of current in the event of a circuit overload. Once a circuit breaker is tripped, it must be reset manually. Press the reset button after the breaker has cooled down. The circuit breakers will not reset until they have had a chance to cool down.

If the overload that caused the circuit breaker to trip is still there, the circuit breaker will continue to stop current flow until the problem is corrected.

Circuit breakers 1 through 9 are located above the foot pedals in the circuit breaker panel.

The chart lists the circuit breakers and the electrical components they protect.

| Circuit Breaker | Rating | Circuit Protected |
|---------------------------|--------|--------------------------------|
| CB-1 | 15 A | Main Power |
| CB-2 | 15 A | Horn |
| CB-3 | 15 A | Side Brushes |
| CB-4 | 15 A | Hopper Door |
| CB-5 | 15 A | Oper. Lights Warning Lights |
| CB-6 | 25 A | Hopper Lift Pump |
| CB-7 | 25 A | Main Brush |
| CB-8 | 20 A | Sweep Fan Motor |
| CB-9 (S/N 000000- 003467) | 20 A | Vac Wand (Option) |
| CB-9 (S/N 003468-) | 25 A | Vac Wand (Option) |

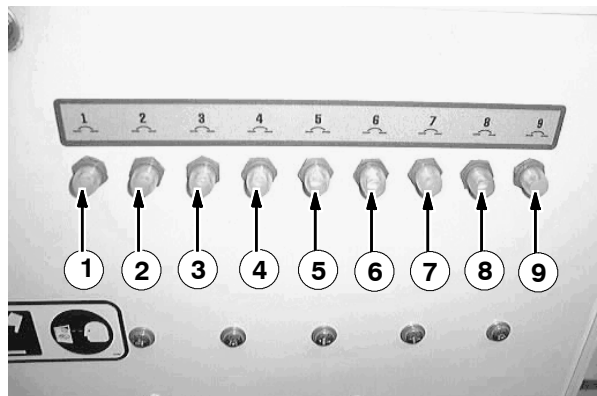

OPERATOR SEAT

The *operator seat* is a fixed back style.

NOTE: The *operator seat* has a safety switch that stops the machine from propelling unless the operator is sitting in the operator's seat.

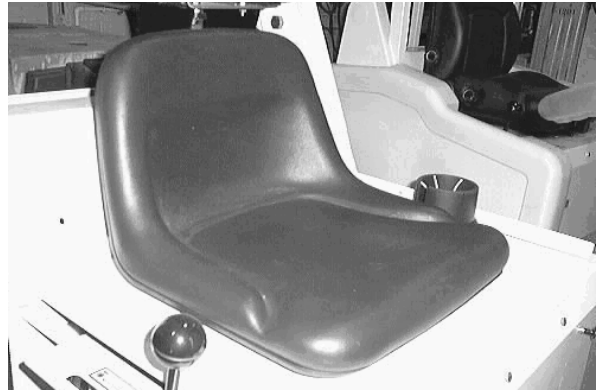
**ADJUSTABLE OPERATOR SEAT (OPTION)**

The *adjustable operator seat* is a fixed back style with a forward- backward adjustment.

Adjust: Pull the lever in, slide the seat backward or forward to the desired position, and release the lever.

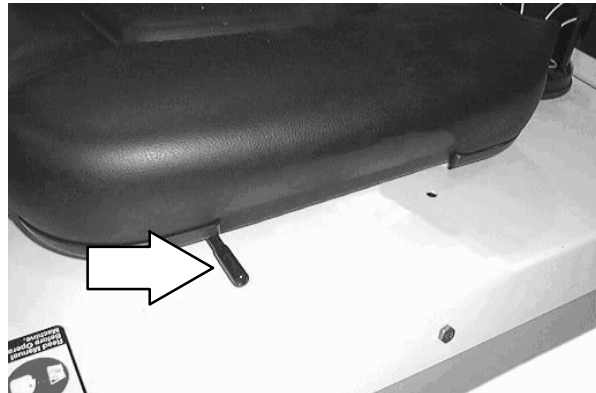
**DELUXE SUSPENSION SEAT (OPTION)**

The *deluxe suspension seat* has four adjustments. The adjustments are for the lumbar support, backrest angle, operator weight adjustment and front to back adjustment.

The *lumbar adjustment knob* controls the firmness of the lumbar support.

Increase firmness: Turn knob clockwise.

Decrease firmness: Turn knob counterclockwise.



The *backrest angle knob* adjusts the angle of the backrest.

Increase angle: Turn the angle adjustment knob counterclockwise.

Decrease angle: Turn the angle adjustment knob clockwise.

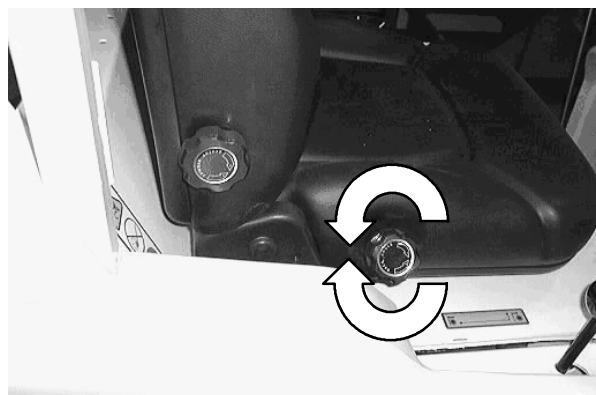

OPERATION

The *weight adjustment knob* controls the firmness of the operator's seat.

Increase firmness: Turn the weight adjustment knob clockwise.

Decrease firmness: Turn the weight adjustment knob counterclockwise.

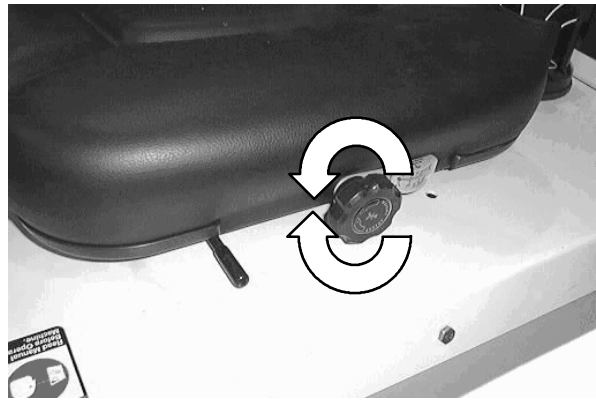

Use the gauge next to the weight adjustment knob to help determine proper seat firmness for the operator.

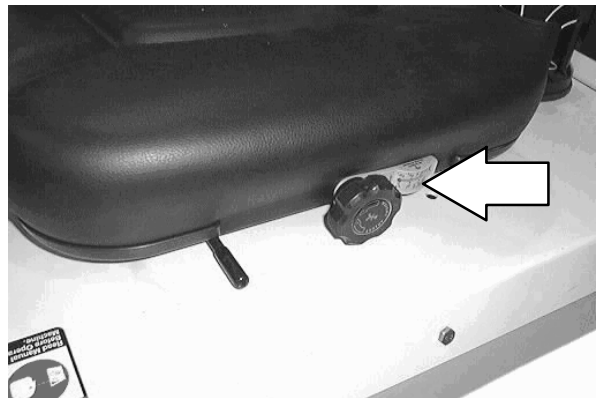

The *front-to-back adjustment lever* adjusts the seat position.

Adjust: Pull the lever out and slide the seat forward or backward to the desired position. Release the lever.

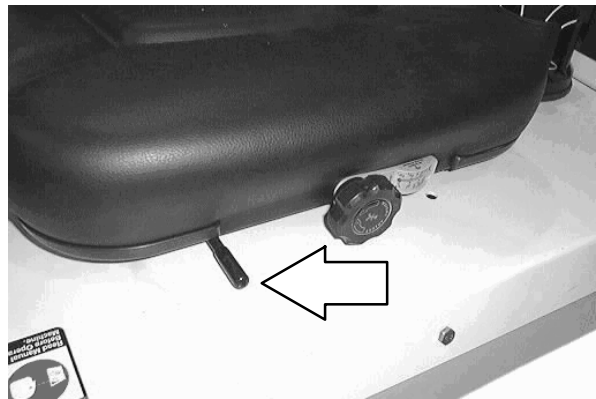

HOPPER SUPPORT BAR

The *hopper support bar* is located on the hydraulic cylinder. It is manually moved into place when the cylinder is fully extended to prevent the hopper from lowering. Lift it off the cylinder before lowering the hopper.

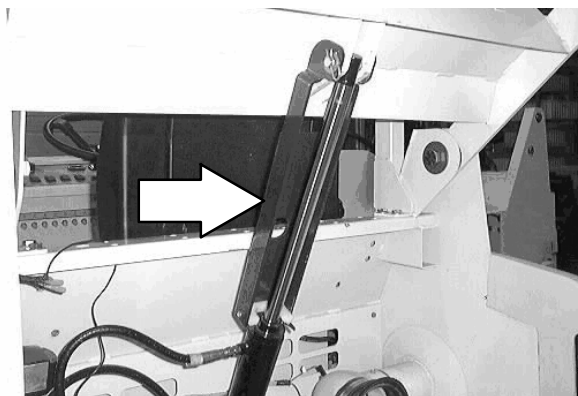

HOW THE MACHINE WORKS

The steering wheel controls the direction of machine travel. The directional pedal controls the speed and forward/reverse direction. The brake pedal slows and stops the machine.

The side brush sweeps debris into the path of the main sweeping brush. The main brush sweeps debris from the floor into the hopper. The large debris trap pedal opens and closes the large debris trap, kicking large debris into the hopper. The vacuum system pulls dust and air into the hopper through the Instant Access filter.

When sweeping is finished, clean the dust filter and empty the hopper.

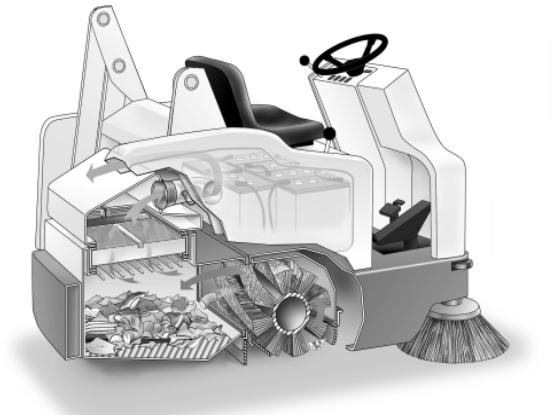

PRE-OPERATION CHECKLIST

- Check the hydraulic fluid level.
- Check the battery fluid and charge level.
- Check the skirts and seals for damage and wear.
- Check the condition of the sweeping brushes. Remove any string, banding, plastic wrap, or other debris wrapped around them.
- Check the sweeping brush patterns for adjustment.
- Check the condition of the hopper dust filter and seals. Clean as required.
- Check the brakes and steering for proper operation.
- Empty the debris hopper.
- Check the service records to determine maintenance requirements.

OPERATION

STARTING THE MACHINE

1. Sit in the operator's seat and engage the brakes with the directional pedal in neutral.

FOR SAFETY: When starting machine, keep foot on brake and directional pedal in neutral.

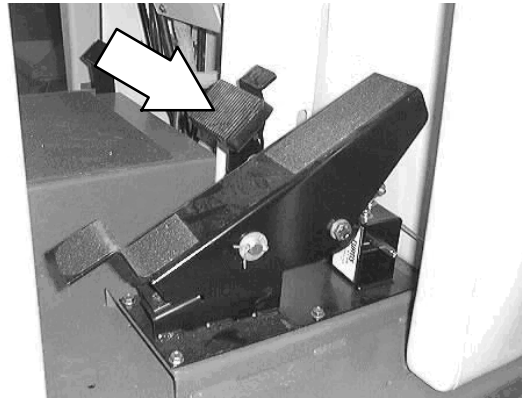

2. Turn the machine power on.

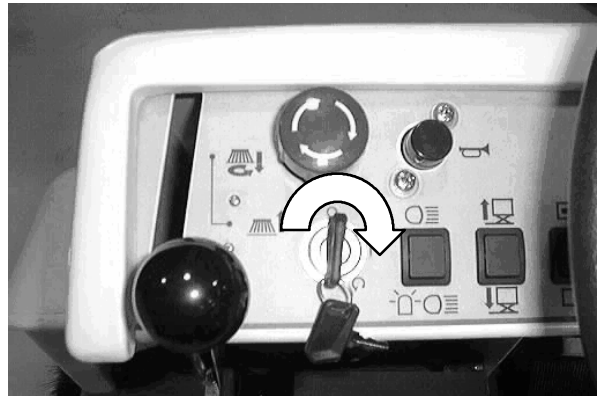

3. Release the machine parking brake.

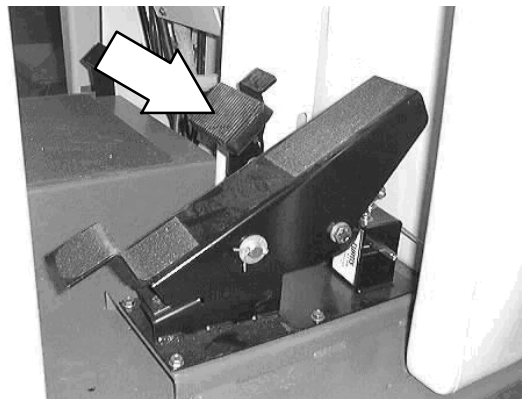

4. Drive the machine to the area to be cleaned.

NOTE: The machine will not travel unless the operator is sitting in the operator's seat.

SWEEPING AND BRUSH INFORMATION

Pick up oversized debris before sweeping. Flatten or remove bulky cartons from aisles before sweeping. Pick up pieces of wire, twine, string, etc., which could become entangled in the brush or brush plugs.

Plan the sweeping in advance. Try to arrange long runs with minimum stopping and starting. Do an entire floor or section at one time. Drive the straightest path possible. Avoid bumping into posts or scraping the sides of the machine. Overlap the brush paths.

Avoid turning the steering wheel too sharply when the machine is in motion. The machine is very responsive to the movement of the steering wheel. Avoid sudden turns, except in emergencies.

For best results, use the correct brush type for your sweeping application. The following are recommendations for main sweeping and side brush applications.

Polypropylene 8-single row main brush -

Superior pick-up of sand, gravel, and paper litter. Polypropylene retains its stiffness when wet and can be used indoors or outdoors with equal performance. Not recommended for high-temperature debris.

Natural Fiber main brush - The natural choice for cleaning fine debris on carpet and sweeping very heavy dust and other fine particles on hard surfaces. When cleaning carpet, check brush and perma filter panel regularly for carpet debris.

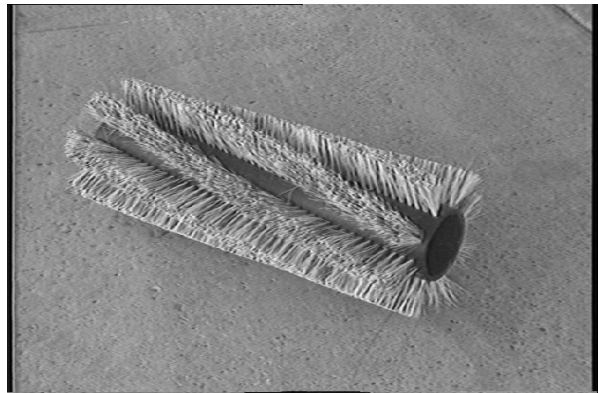

Sand Wedge main brush - A fine brush that handles large quantities of dust and sand with ease.



OPERATION

Side Brush (2 Row) - A good general purpose brush for sweeping of light to medium debris in both indoor and outdoor applications. This brush is recommended when bristles may get wet.

Side Brush (3 Row) - Improved sweeping performance of fine materials on smooth indoor surfaces.

Stiff Side Brush - A longer life, general purpose brush that is recommended for rough surfaces.



SWEEPING

1. Press the top of the *vacuum fan and filter shaker switch* to the on position.



2. Lower and start the main brush with the *main brush lever*.



3. Lower and start the side brush(es) with the *side brush lever*.

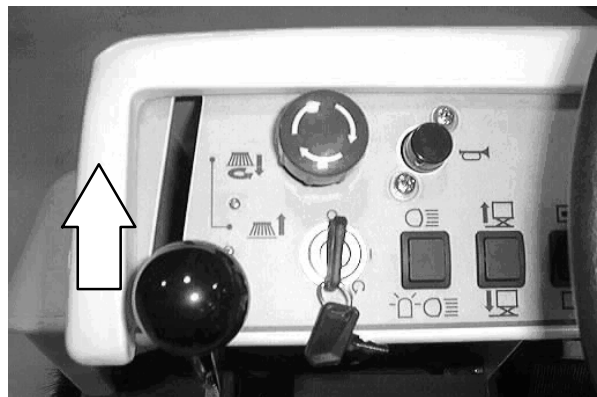

4. Begin sweeping.

OPERATION

5. Press down on the *large debris trap pedal* when sweeping large debris.

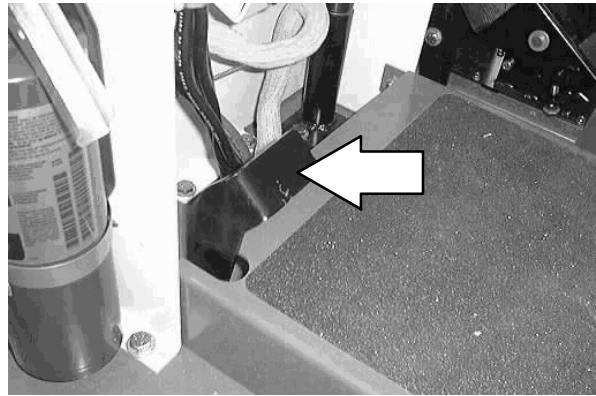

6. Release the pedal, and the flap will lower over the debris.

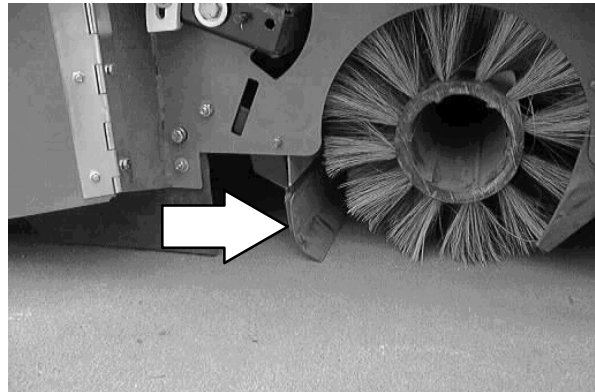

7. The flap will trap large debris back into the hopper.

STOP SWEEPING

1. Raise and stop the side brush(es) with the *side brush lever*.

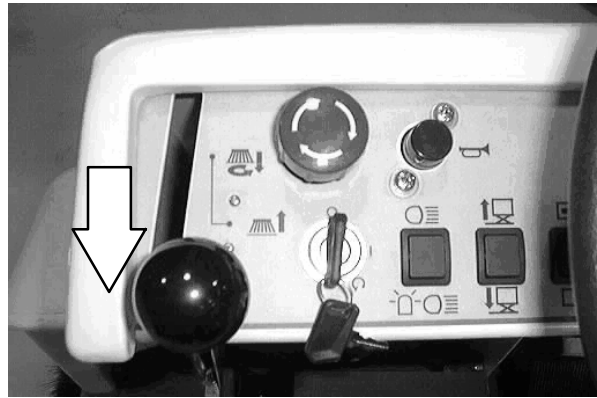

2. Raise and stop the main brush with the *main brush lever*.



3. Press and hold the bottom of the *vacuum fan and filter shaker switch* for eight to ten seconds to start the filter shaker.



EMPTYING THE HOPPER

1. Stop sweeping. See the STOP SWEEPING section of the manual.
2. Drive the machine to the debris site or debris container.
3. Press and hold the top of the *hopper switch* to raise the hopper to the desired height. Release the switch into the hold position.

 **WARNING: Lift arm pinch point. Stay clear of hopper lift arms.**

FOR SAFETY: When using machine, make sure adequate clearance is available before raising hopper.

NOTE: Be aware that the minimum ceiling height needed to high dump the hopper is 2286 mm (90 in).

4. Back the machine up to the debris container. Position the hopper over the debris container.
5. Press and hold the top of the *hopper door switch* until the hopper is fully open. Release the switch into the hold position.

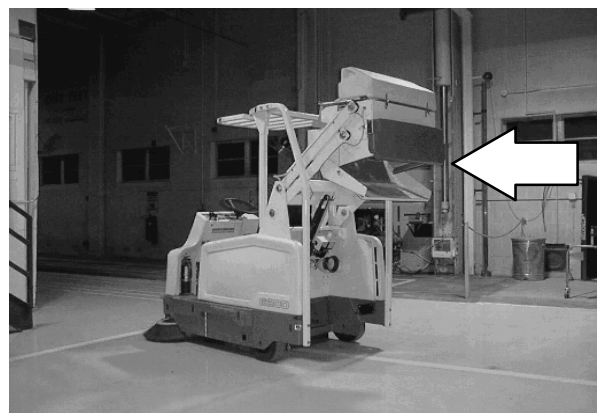
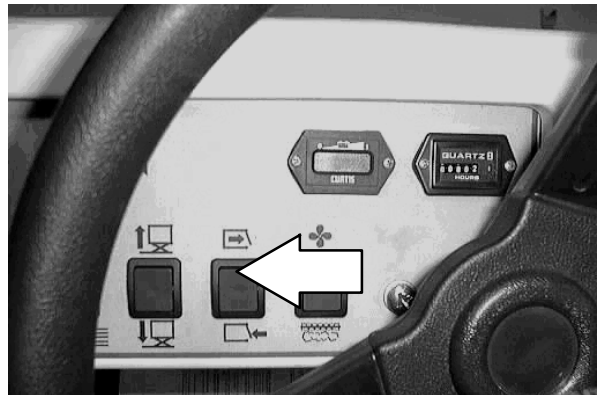
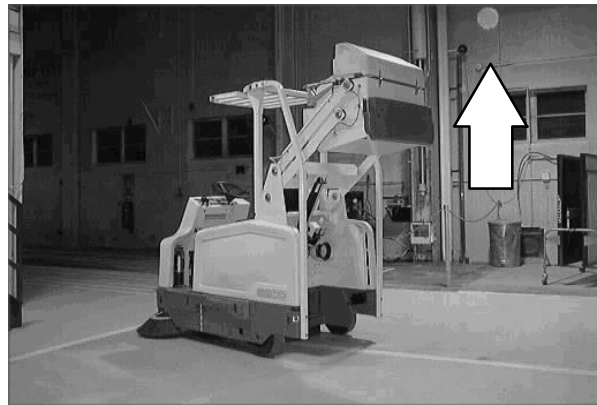

6. Press and hold the bottom of the *hopper door switch* until the hopper door is fully closed.

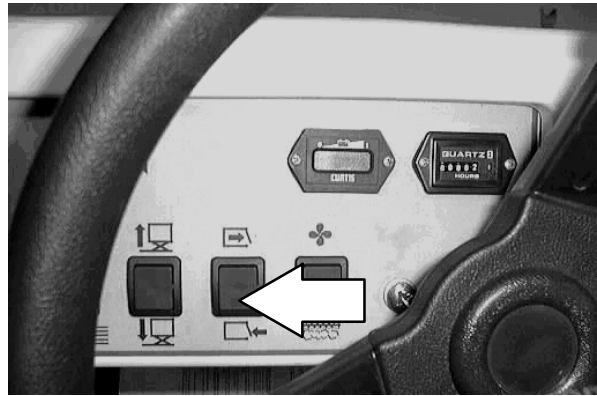

7. Press and hold the bottom of the *hopper switch* until the hopper is fully lowered.

 **WARNING: Lift arm pinch point. Stay clear of hopper lift arms.**



OPERATION

STOPPING THE MACHINE

1. Stop sweeping. See the STOP SWEEPING section of the manual.
2. Take your foot off the directional pedal. Step on the brake pedal.

NOTE: The machine may coast for a short distance when your foot is removed from the directional pedal. Use the brake pedal to stop the machine.

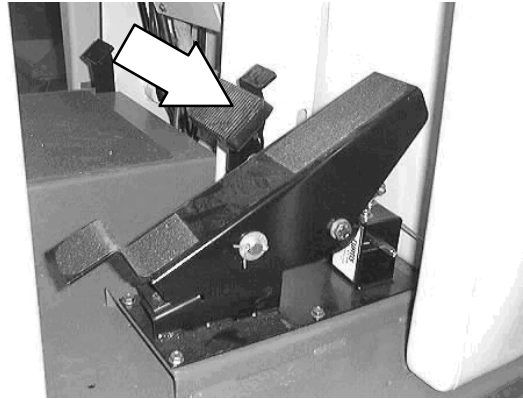

3. Set the machine parking brake.

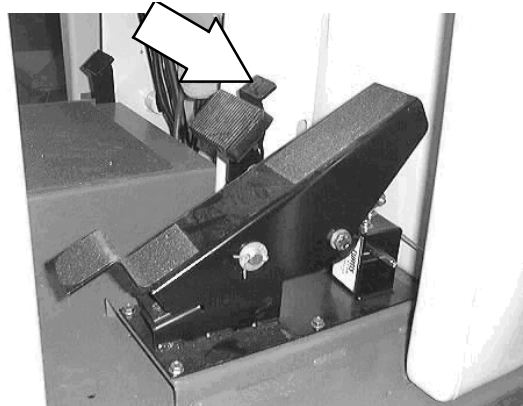

4. Turn the machine power off. Remove the switch key.

FOR SAFETY: Before leaving or servicing machine, stop on level surface, set parking brake, turn off machine, and remove key.

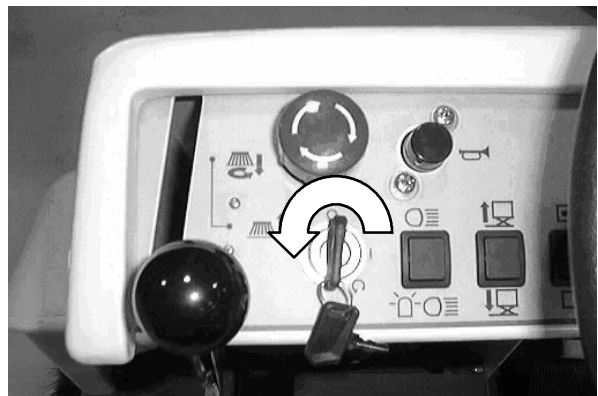

POST-OPERATION CHECKLIST

Check this list of items after you have finished sweeping:

- Check the hydraulic fluid level.
- Check the battery fluid and charge level.
- Check the skirts and seals for damage and wear.
- Check the condition of the sweeping brushes. Remove any string, banding, plastic wrap, or other debris wrapped around them.
- Check the sweeping brush patterns for adjustment.
- Check the condition of the hopper dust filter and seals. Clean as required.
- Check the brakes and steering for proper operation.
- Empty the debris hopper.
- Check the service records to determine maintenance requirements.

OPERATION

ENGAGING HOPPER SUPPORT BAR

1. Set the machine parking brake.

FOR SAFETY: When starting machine, keep foot on brake and directional pedal in neutral.

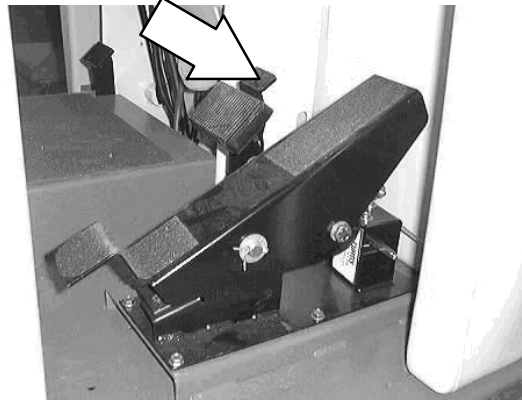

2. Turn the machine power on.

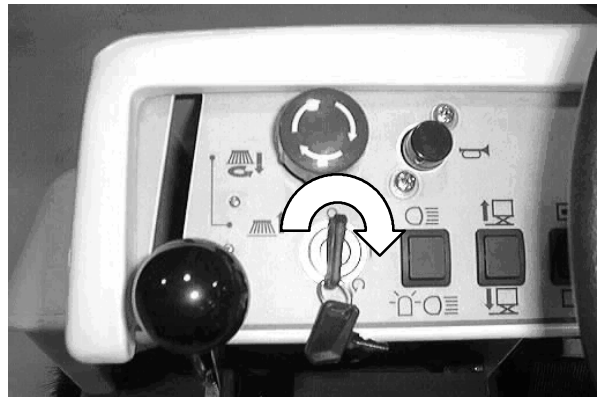

3. Press and hold the top of the hopper switch until the hopper is fully raised. Release the switch into the hold position.

! WARNING: Lift arm pinch point. Stay clear of hopper lift arms.

FOR SAFETY: When using machine, make sure adequate clearance is available before raising hopper.

NOTE: Be aware that the minimum ceiling height needed to high dump the hopper is 2286 mm (90 in).

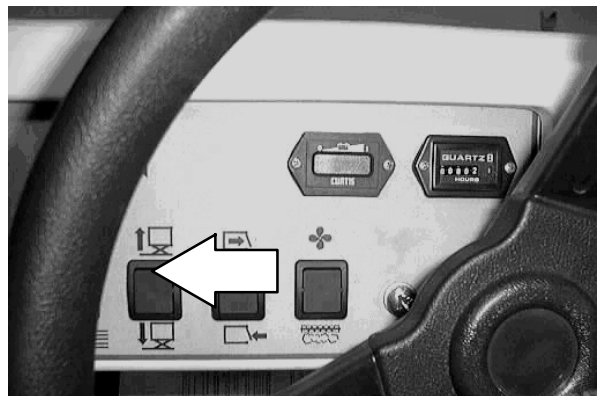

4. Push the hopper support bar in place onto the support cylinder.

! WARNING: Raised hopper may fall. Engage hopper support bar

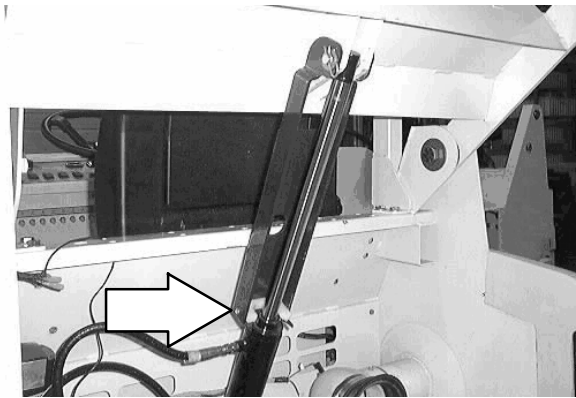

5. Slowly lower the hopper by pressing down and holding the *hopper switch* until the hopper support bar rests on the support bar stop.

! WARNING: Lift arm pinch point. Stay clear of hopper lift arms.



6. Turn the machine power off.

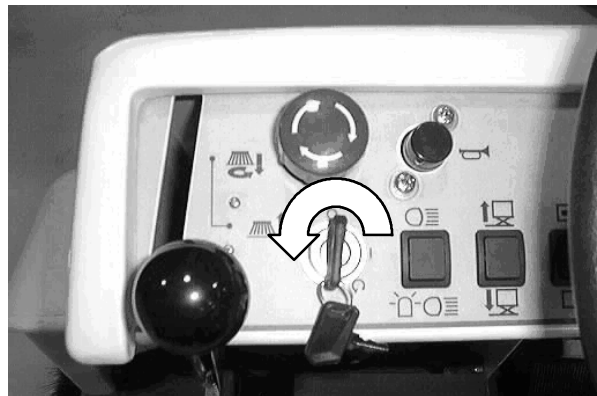

OPERATION

DISENGAGING HOPPER SUPPORT BAR

1. Turn the machine power on.

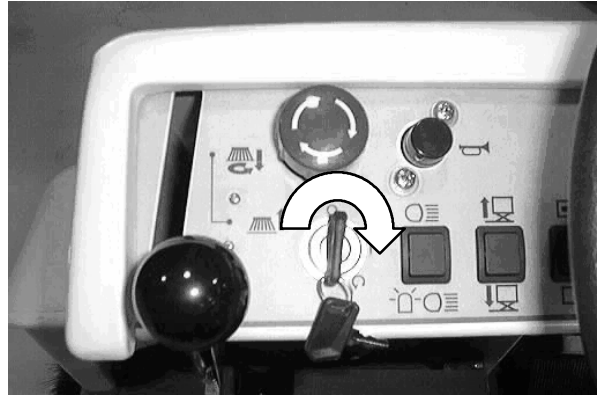

2. Raise the hopper slightly by pressing up and holding the *hopper switch*. Release the switch into the hold position.

NOTE: Be aware that the minimum ceiling height needed to high dump the hopper is 2286 mm (90 in).

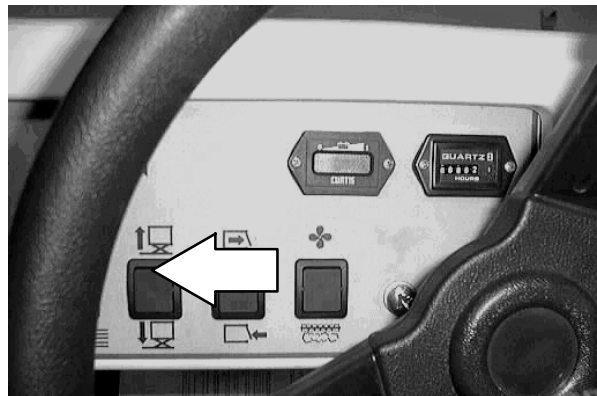

3. Move the hopper support bar off the cylinder into the storage position.

⚠ WARNING: Lift arm pinch point. Stay clear of hopper lift arms.

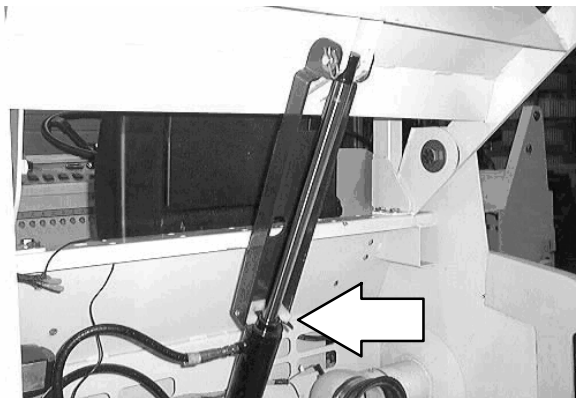

4. Press and hold the bottom of the hopper switch until the hopper is in the fully lowered position.

 **WARNING: Lift arm pinch point. Stay clear of hopper lift arms.**

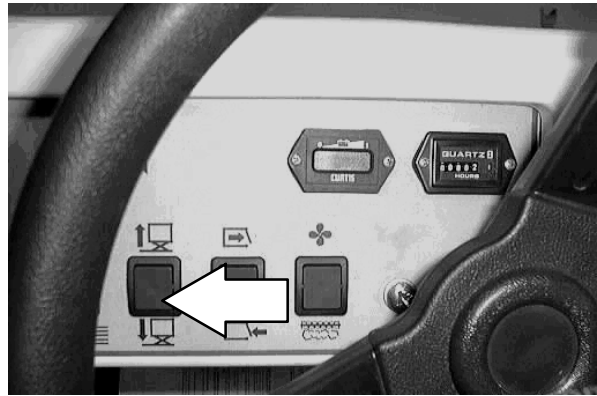

5. Turn the machine power off.

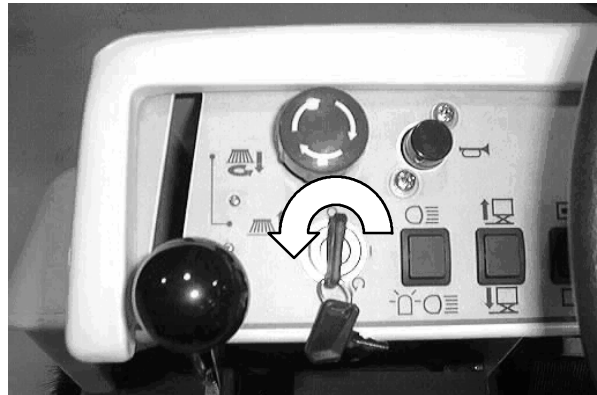

OPERATION ON INCLINES

Drive the machine slowly on inclines. Use the brake pedal to control machine speed when descending inclines.

The maximum rated incline is 6°/11% with a full hopper and 10°/18% with an empty hopper.

FOR SAFETY: When using machine, go slowly on inclines and slippery surfaces.

OPTIONS

VACUUM WAND

The vacuum wand uses a separate vacuum system to pick-up any debris that is out of reach of the machine.

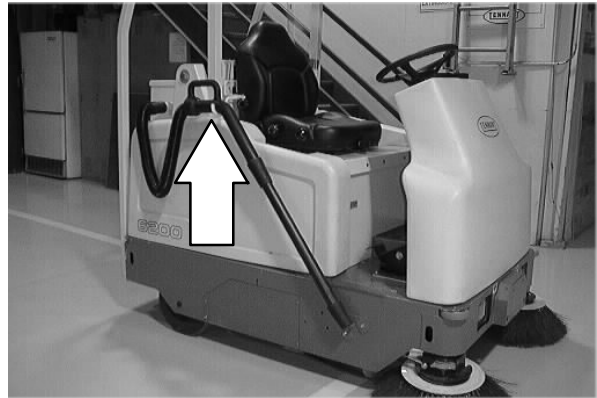

1. Turn machine on.

NOTE: The vacuum fan and filter shaker switch does not have to be turned on for the vacuum wand system to operate.

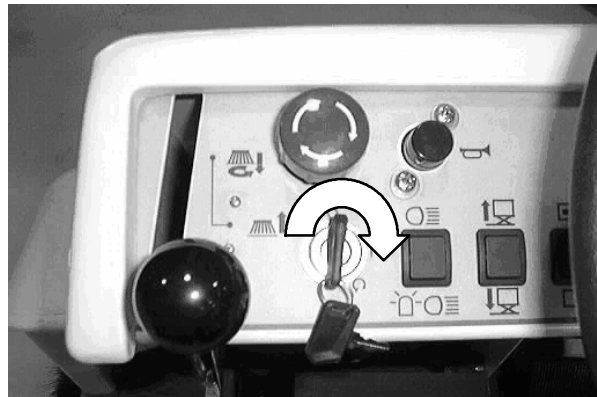

2. Turn the cam knob counterclockwise to release the vacuum wand rod handle.



3. Wand On: Raise the vacuum wand from the storage position. The vacuum will turn on automatically.
4. Wand Off: Return the vacuum wand back to storage position and the vacuum will turn off.

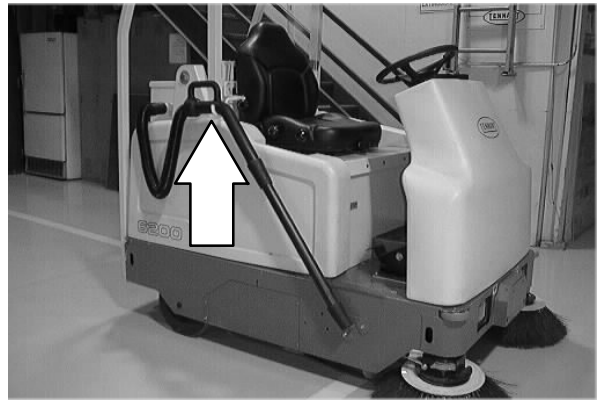

5. Turn the cam knob clockwise to secure vacuum wand rod handle.

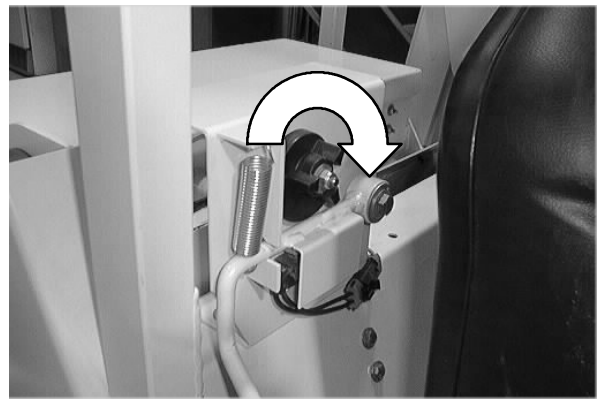

6. Replace full vacuum bags whenever wand begins to lose power or when bags are full.



OPERATION

QUICK MOP

The *QuickMop* is a front end sweeping attachment that widens the machine's sweeping path.

1. Drive the machine close to QuickMop attachment.
2. Set the machine parking brake and turn the machine power off.

FOR SAFETY: Before leaving or servicing machine, stop on level surface, set parking brake, turn off machine, and remove key.



3. Connect the QuickMop attachment to the mounting bracket on the front of the machine.

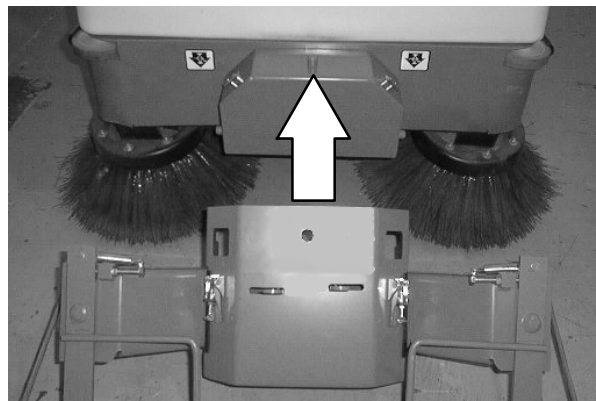

4. Fasten the latches on the front of the mounting bracket. Release the parking brake and drive to the designated area to be swept.

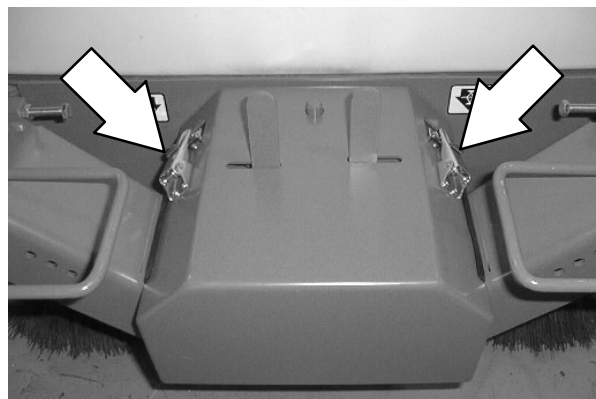

5. Pull the release lever to raise or lower each side of the QuickMop.

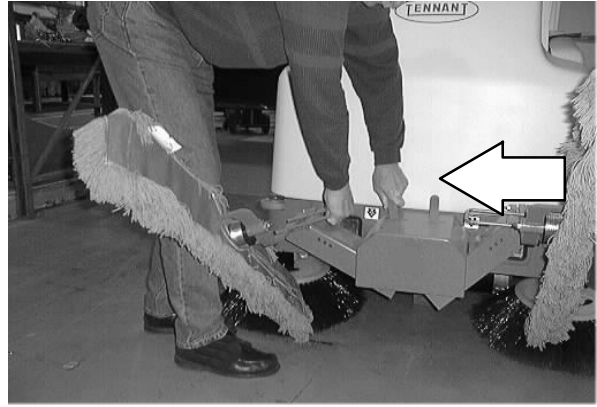

6. Turn the vacuum and brushes on, lower brushes and begin sweeping.

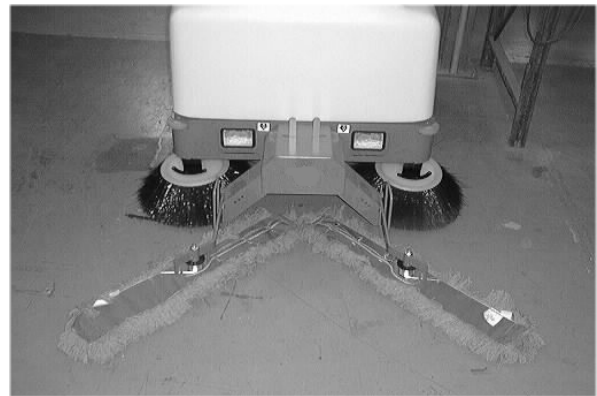

7. Remove and refasten the QuickMop head covers with the easy to remove snaps. Remove the head covers to rotate, shake and clean at regular intervals.

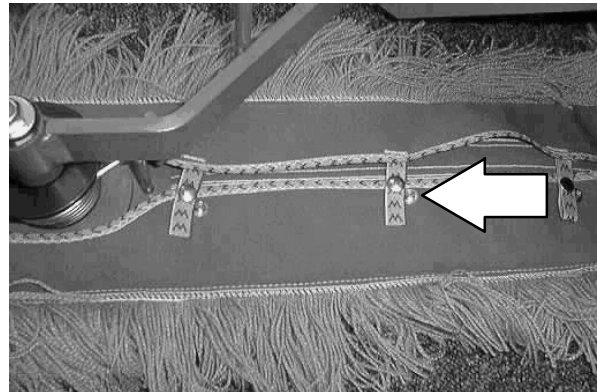

OPERATION

ROLLOUT BATTERY

The rollout battery allows the operator a quick and easy way to remove and replace the batteries from the machine.

1. Drive the machine to a flat, dry surface.
2. Turn the machine off and set the parking brake.

FOR SAFETY: Before leaving or servicing machine, stop on level surface, set parking brake, turn off machine, and remove key.

3. Lift the operator seat to access the batteries. The support arm automatically engages when the seat is lifted all the way up.
4. Unplug the machine connector from the batteries.

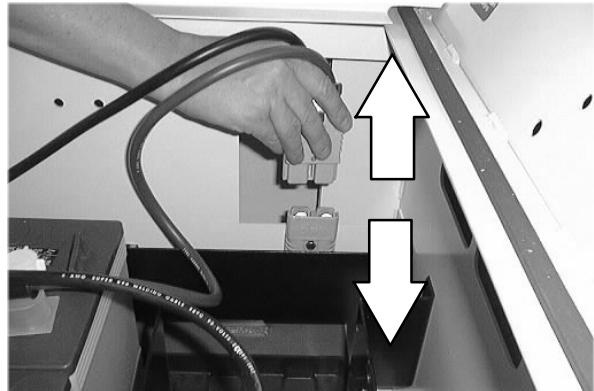

5. Remove the left side panel and push the battery cart to the left side of the machine. Line up the battery cart locks and the slots on the machine. Push the battery cart forward.

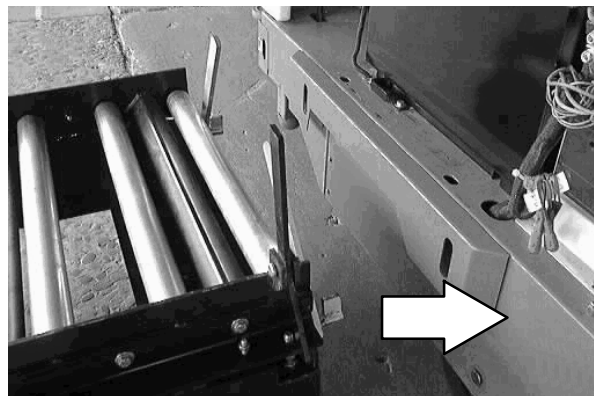

6. Lock the battery cart to the machine by pulling the battery cart locks towards the outside of the battery cart.

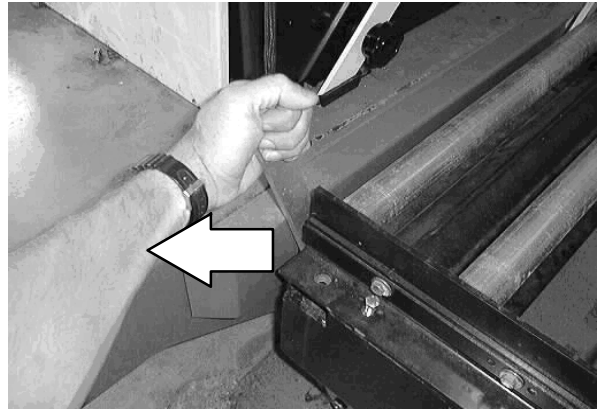

7. Set the battery cart floor lock by stepping down on the left side of the floor lock.



8. Adjust the battery cart rollers before rolling out the batteries. The battery cart rollers must be the same height as the machine battery rollers.

Raise the battery cart rollers: With a wrench, loosen the jam nut and turn the bolt clockwise. Tighten the jam nuts.

Lower the battery cart rollers: With a wrench, loosen the jam nut and turn the bolt counter-clockwise. Tighten the jam nuts.

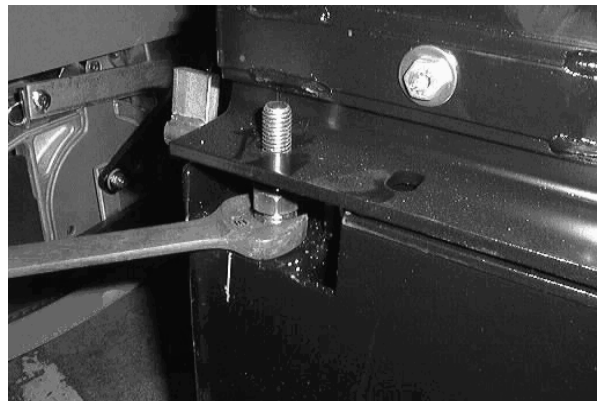

OPERATION

9. Turn the knob on the machine's battery stop arm counterclockwise until it stops turning.



10. Raise the machine's battery stop arm all the way to the horizontal position.

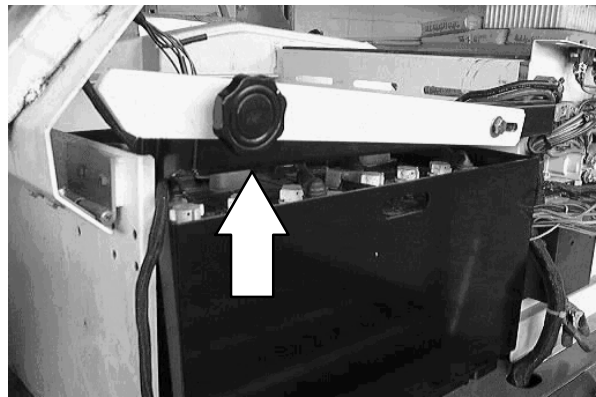

11. Raise the cart's battery stop bar by pushing down on the handle.



12. Grab the battery case slot and pull the battery case onto the battery cart.

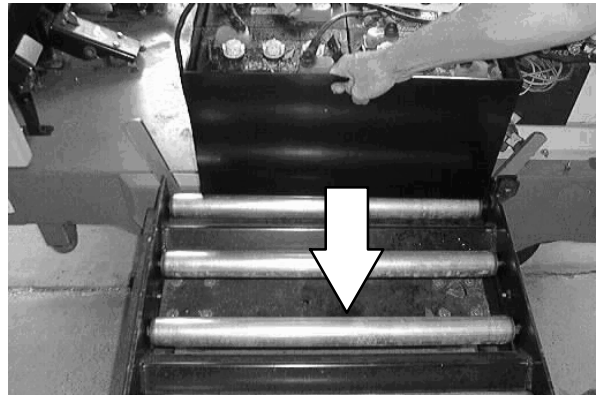

13. Lower the cart's battery stop bar by pulling up on the handle. This will keep the batteries from rolling off the cart when moving.

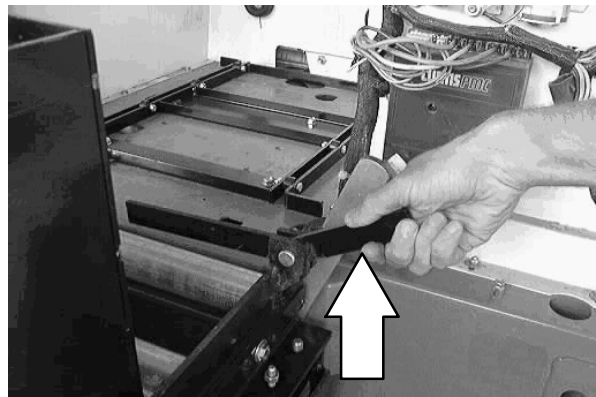

OPERATION

14. Release the battery cart from the machine by pushing the battery cart locks towards the inside of the battery cart.

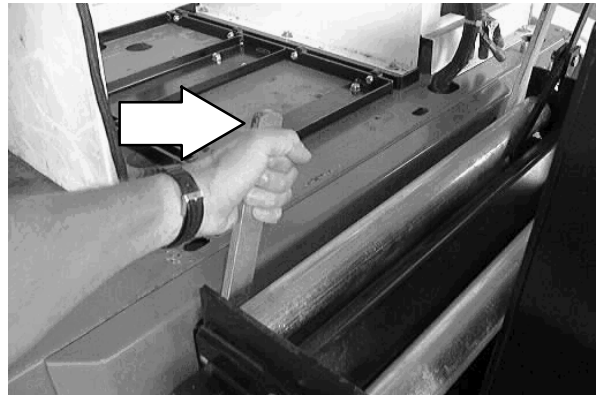

15. Release the battery cart floor lock. To release the floor lock, step down on the right side of the floor lock.

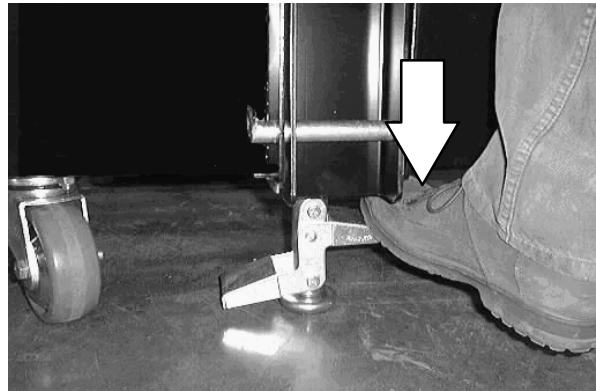

16. Pull the battery cart away from the machine.

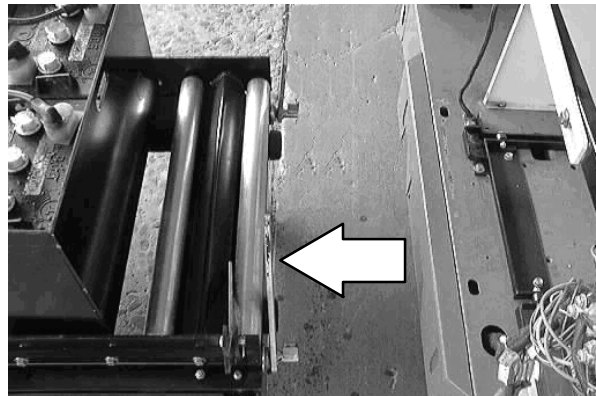

17. Reverse the previous steps to re-install the batteries in the machine.

MACHINE TROUBLESHOOTING

| Problem | Cause | Remedy |
|---------------------------|--|--|
| No machine power | Power kill switch on | Turn kill switch clockwise until it pops up. Turn machine off and on |
| | Batteries not connected | Connect batteries to machine |
| Low machine power | Low battery power | Check and charge batteries |
| Machine does not propel | Operator not in seat | Sit in operator seat |
| Excessive dusting | Vacuum fan off | Press the vacuum and filter shaker switch to the on position |
| | Brush skirts and dust seals worn, damaged, out of adjustment | Replace or adjust brush skirts or dust seals |
| | Hopper dust filter clogged | Shake and/or clean or replace dust filter |
| | Vacuum fan failure | Contact Tennant service personnel |
| | Thermo Sentry tripped | Remove heat source from hopper. Restart machine |
| Poor sweeping performance | Brush bristles worn | Replace brushes |
| | Main and/or side brushes not adjusted properly | Adjust main and/or side brushes |
| | Debris caught in main brush drive mechanism | Remove debris from drive mechanism |
| | Main brush drive failure | Contact Tennant service personnel |
| | Side brush drive failure | Contact Tennant service personnel |
| | Hopper full | Empty hopper |
| | Hopper lip skirts worn or damaged | Replace lip skirts |
| | Wrong sweeping brush | Contact Tennant representative for recommendations |
| | Large debris trap damaged | Repair or replace large debris trap |
| | Hopper dust filter clogged | Shake and/or clean or replace dust filter |
| | Recirculation skirt edge not folded in | Fold in skirt edge |
| | Recirculation flap damaged | Replace flap |

MAINTENANCE

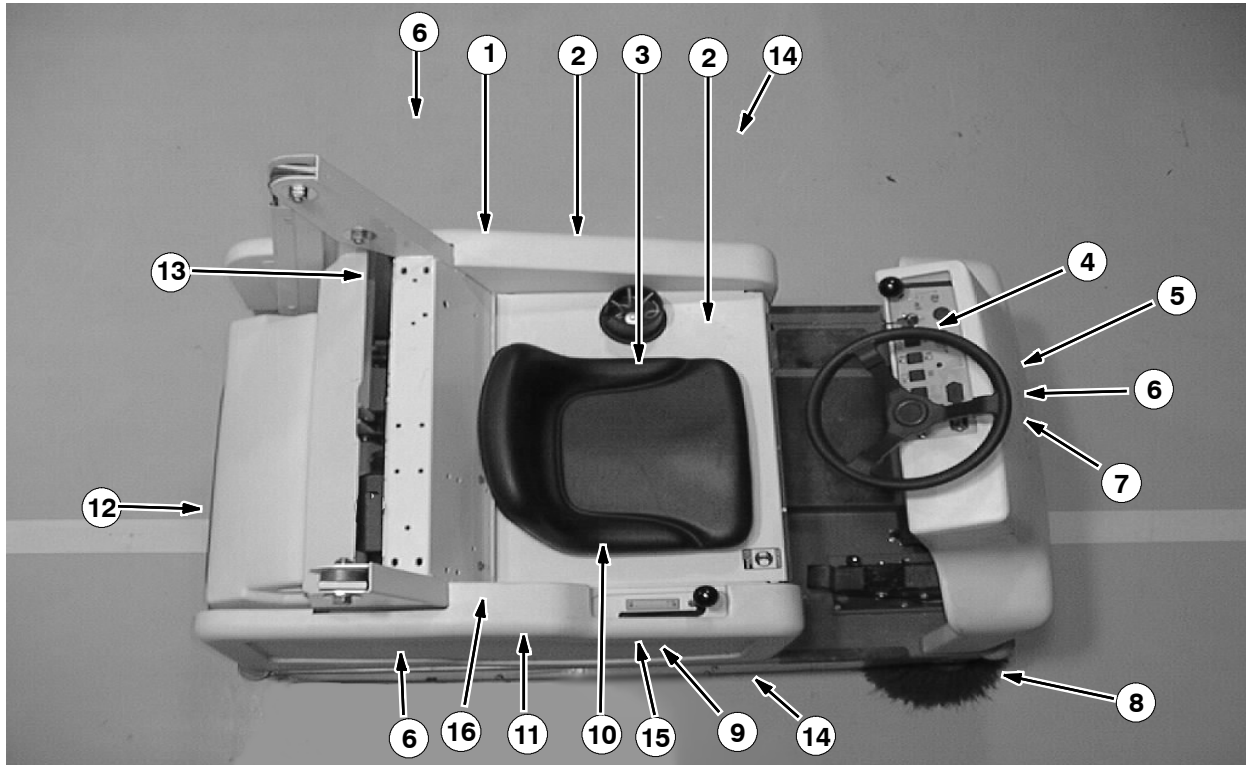

MAINTENANCE CHART

NOTE: Check procedures indicated (■) after the first 50 hours of operation.

| Interval | Key | Description | Procedure | Lubricant/ Fluid | No. of Service Points |
|----------|--------------------|--------------------------|---|---------------------|-----------------------------|
| Daily | 2 | Brush compartment skirts | Check for damage, wear and adjustment | - | 5 |
| | 14 | Side skirts | Check for damage, wear and adjustment | - | 2 |
| | 10 | Main brush | Check for damage, wear and adjustment | - | 1 |
| | | | | - | 1 |
| | 8 | Side brush(es) | Check for damage or wear Check brush pattern | - | 1 |
| | | | | - | 1 |
| 12 | Hopper dust filter | Shake | - | 1 | |
| 50 Hours | 10 | Main brush | Rotate end-for-end | - | 1 |
| | - | QuickMop broom (Option) | Rotate or wash sweep heads | - | 2 |
| | 3 | Batteries | Check electrolyte level | DW | 6 (3) |
| | - | Vacuum wand bag (Option) | Check or change vacuum bag | - | 1 |
| | - | Vacuum wand fan (Option) | Check for damage or wear | - | 1 |

| Interval | Key | Description | Procedure | Lubricant/ Fluid | No. of Service Points |
|------------|-----|-------------------------------|-------------------------------------|---------------------|-----------------------------|
| 100 Hours | 12 | Hopper dust filter | Change for damage, clean or replace | - | 1 |
| | 13 | Hydraulic reservoir | Check fluid level | HYDO | 1 |
| | 6 | Tires | Check for damage | - | 3 |
| | 1 | Hopper seals | Check for damage or wear | - | 6 |
| | 1 | Hopper filter seals | Check for damage or wear | - | 2 |
| | 12 | Vacuum seal | Check for damage or wear | - | 1 |
| | 2 | Large debris trap skirt | Check for damage or wear | - | 1 |
| | 7 | Steering castor pivot bearing | Lubricate and check for wear | SPL | 1 |
| | 11 | Vacuum fan belt | Check tension and wear | - | 1 |
| | 9 | Main brush belt | Check for wear | - | 1 |
| 200 Hours | 5 | Brakes | Check and adjust travel | - | 1 |
| | 4 | Steering gear chain | Lubricate | EO | 1 |
| | 8 | Side brush(es) guard | Check for damage or wear | - | 1 (2) |
| | 3 | Battery terminals and cables | ■ Check and clean | - | 12 |
| 800 Hours | 13 | Hydraulic hoses | Check for wear and damage | - | 2 |
| | 7 | Propelling motor | Check carbon brushes | - | 1 |
| | 6 | Rear wheels | ■ Check rear wheel axle torque | - | 1 |
| | 15 | Main brush motor | Check carbon brushes | - | 1 |
| | 16 | Vacuum fan motor | Check carbon brushes | - | 1 |
| 2400 Hours | 13 | Hydraulic fluid reservoir | * Change hydraulic fluid | HYDO | 1 |

NOTE: Change the hydraulic fluid, filter, and suction strainer, indicated (), after every 800 hours for machines NOT originally equipped with **TennantTrue** premium hydraulic fluid. (See Hydraulics section).*

LUBRICANT/FLUID

DW . . . Distilled water

EO . . . SAE 30 Engine oil

HYDO . **TennantTrue** premium hydraulic fluid or equivalent

SPL . . . Special lubricant, Lubriplate EMB grease (TENNANT part no. 01433- 1)

NOTE: More frequent intervals may be required in extremely dusty conditions.

LUBRICATION

STEERING GEAR CHAIN

The steering chain turns the front wheel as the steering wheel is turned to steer the machine. Lubricate the steering chain with SAE 30- weight engine oil after every 200 hours of operation.

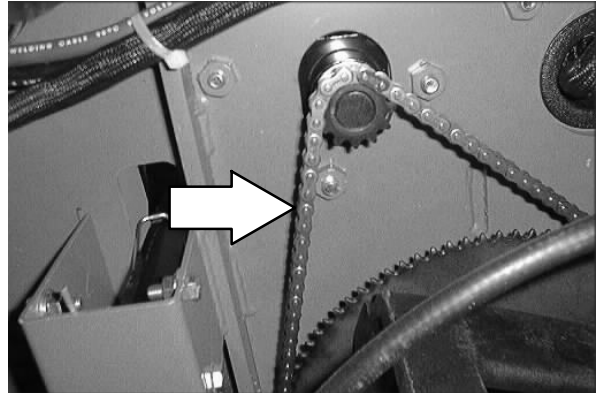

STEERING CASTOR PIVOT BEARING

The steering castor bearing is located under the floorplate. Remove the floorplate, and lubricate the bearing with Lubriplate EMB grease (TENNANT part no 01433- 1) every 100 hours.

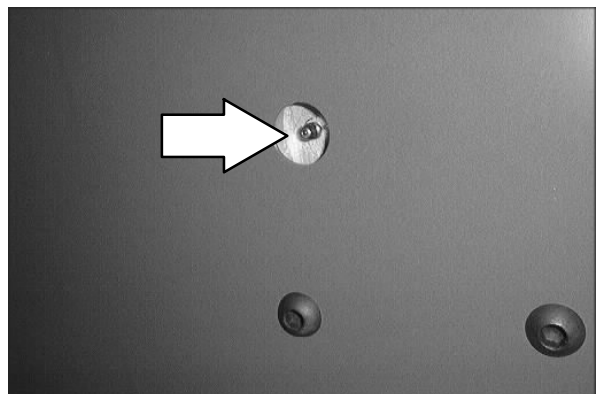
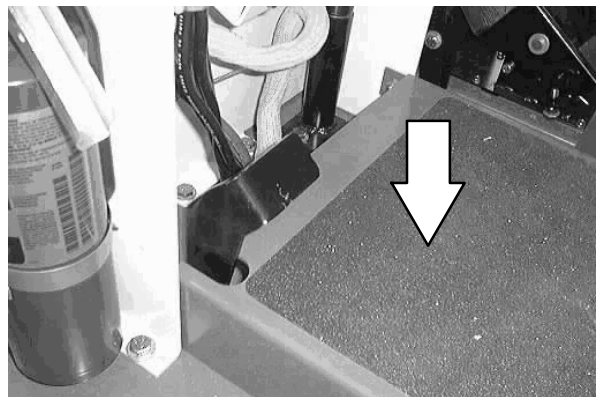

HYDRAULICS

HYDRAULIC FLUID RESERVOIR

The reservoir is located behind the debris hopper.

A filler cap is mounted on top of the reservoir.

Raise the hopper and check the hydraulic fluid level at operating temperature after every 100 hours of operation. Make sure the hopper support bar is in place before checking hydraulic fluid level. The side of the reservoir is marked with FULL and ADD levels to indicate the level of hydraulic fluid in the reservoir.

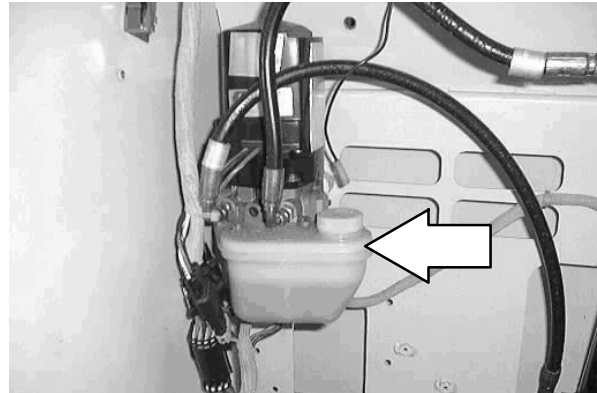

! WARNING: Lift arm pinch point. Stay clear of hopper lift arms.

! WARNING: Raised hopper may fall. Engage hopper support bar

ATTENTION! Do not overfill the hydraulic fluid reservoir or operate the machine with a low level of hydraulic fluid in the reservoir. Damage to the machine hydraulic system may result.

Drain and refill the hydraulic fluid reservoir with new **TennantTrue** premium hydraulic fluid after every 2400 hours of operation. Machines have a blue colored drop (left photo) on the hydraulic fluid label if originally equipped with **TennantTrue** premium hydraulic fluid.



TennantTrue Fluid



Previous Fluid

*NOTE: Change the hydraulic fluid after every 800 hours for ALL machines that have NOT consistently used **TennantTrue** premium hydraulic fluid or equivalent.*

HYDRAULIC FLUID

The quality and condition of the hydraulic fluid play a very important role in how well the machine operates. Tennant's hydraulic fluid is specially selected to meet the needs of Tennant machines.

Tennant's hydraulic fluid provides a longer life for the hydraulic components.

| TennantTrue premium hydraulic fluid (Extended Life) | | | |
|---|---------------------|-----------|---------------|
| Part number | Ambient temperature | ISO Grade | Capacity |
| 1057707 | below 7° C (45° F) | 32 | 3.8 L (1 gal) |
| 1057708 | below 7° C (45° F) | 32 | 19 L (5 gal) |

If a locally available hydraulic fluid is used, make sure the specifications match Tennant hydraulic fluid specifications. Using substitute fluids can cause premature failure of hydraulic components.

ATTENTION! Hydraulic components depend on system hydraulic fluid for internal lubrication. Malfunctions, accelerated wear, and damage will result if dirt or other contaminants enter the hydraulic system.

HYDRAULIC HOSES

Check the hydraulic hoses after every 800 hours of operation for wear or damage.

Fluid escaping at high pressure from a very small hole can be almost invisible, and can cause serious injuries.

See a doctor at once if injury results from escaping hydraulic fluid. Serious infection or reaction can develop if proper medical treatment is not given immediately.

FOR SAFETY: When servicing machine, use cardboard to locate leaking hydraulic fluid under pressure.

If you discover a fluid leak, contact your mechanic or supervisor.

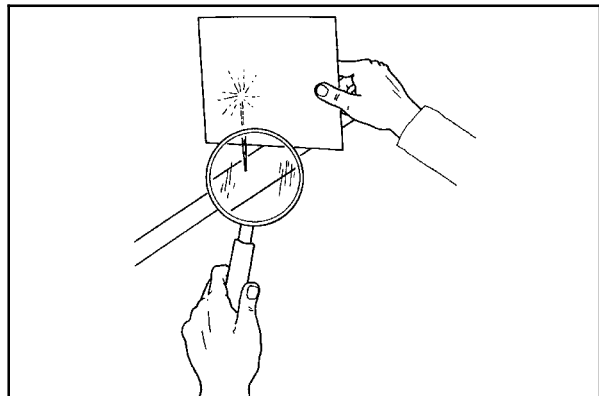

00002

BATTERIES

FOR SAFETY: Before leaving or servicing machine, stop on level surface, set parking brake, turn off machine, and remove key.

The lifetime of the batteries depends on their proper maintenance. To get the most life from the batteries;

- Do not charge the batteries more than once a day and only after running the machine for a minimum of 15 minutes.
- Do not leave the batteries partially discharged for long period of time.
- Only charge the batteries in a well-ventilated area to prevent gas build up. Charge batteries in areas with ambient temperatures 27°C (80°F) or less.
- Allow the charger to complete charging the batteries before re-using the machine.
- Maintain the proper electrolyte levels of flooded (wet) batteries by checking levels weekly.

CHECKING THE ELECTROLYTE LEVEL

The flooded (wet) lead- acid batteries require routine maintenance as described below. Check the battery electrolyte level weekly.

*NOTE: **Do Not** check the electrolyte level if the machine is equipped with the battery watering system. Proceed to the BATTERY WATERING SYSTEM (OPTION).*

FOR SAFETY: When servicing machine, keep all metal objects off batteries. Avoid contact with battery acid.

The level should be slightly above the battery plates as shown before charging. Add distilled water if low. DO NOT OVERFILL. The electrolyte will expand and may overflow when charging. After charging, distilled water can be added up to about 3 mm (0.12 in) below the sight tubes.

NOTE: Make sure the battery caps are in place while charging. There may be a sulfur smell after charging batteries. This is normal.

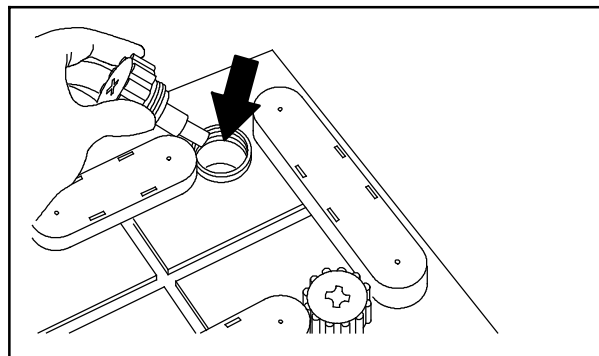

08247

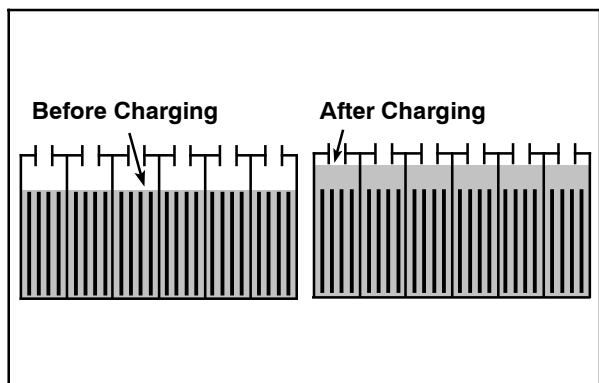

MAINTENANCE

MAINTENANCE-FREE BATTERIES

Maintenance-free batteries do not require watering. Cleaning and other routine maintenance is still required.

CHECKING CONNECTIONS / CLEANING

After every 200 hours of use check for loose battery connections and clean the surface of the batteries, including terminals and cable clamps, with a strong solution of baking soda and water. Replace any worn or damaged wires. Do not remove battery caps when cleaning batteries.



CHARGING THE BATTERIES

1. Drive the machine to a flat, dry surface in a well-ventilated area.
2. Stop the machine, set the parking brake and turn the machine power off.

FOR SAFETY: Before leaving or servicing machine, stop on level surface, set parking brake, turn off machine, and remove key.

3. Open the seat support.

⚠ WARNING: Batteries emit hydrogen gas. Explosion or fire can result. Keep sparks and open flame away. Keep covers open when charging.

NOTE: Make sure the batteries have the proper electrolyte level before charging. See CHECKING THE ELECTROLYTE LEVEL.

NOTE: Make sure the battery caps are in place while charging.

FOR SAFETY: When maintaining or servicing machine, avoid contact with battery acid.

- Unplug the battery connector from the machine connector.

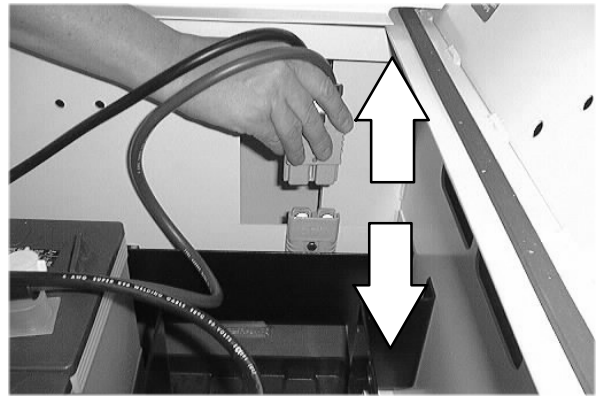

- Plug the charger connector into the battery connector.

⚠ WARNING: Batteries emit hydrogen gas. Explosion or fire can result. Keep sparks and open flame away. Keep covers open when charging.

NOTE: If the red "ABNORMAL CYCLE" lamp lights when the batteries are plugged into the TENNANT charger, this indicates that something is wrong with the battery. The charger can not charge the battery when this happens.

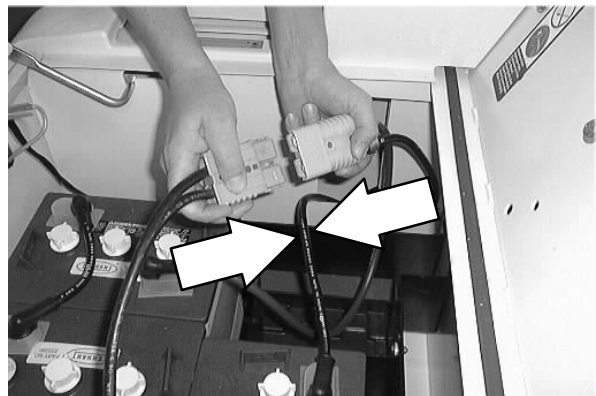

- The Tennant charger will start automatically. When the batteries are fully charged, the Tennant charger will automatically turn off.

NOTE: Use a charger with the proper rating for the batteries to prevent damage to the batteries or reduce the battery life.

NOTE: If the charger needs to be disconnected from the machine before the batteries are fully charged and the charger has not automatically shut off, turn off the charger before disconnecting it.



- After the charger has turned off, unplug the charger connector from the battery connector on the machine.

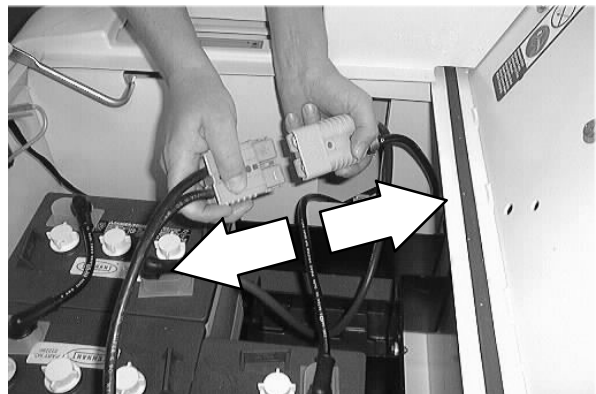

MAINTENANCE

8. Reconnect the battery connector to the machine connector.
9. Check the electrolyte level in each battery cell after charging. If needed, add distilled water to raise the electrolyte level to about 12mm (0.4in) below the bottom of the sight tubes.

FOR SAFETY: When maintaining or servicing machine, avoid contact with battery acid.

10. Close the seat support.

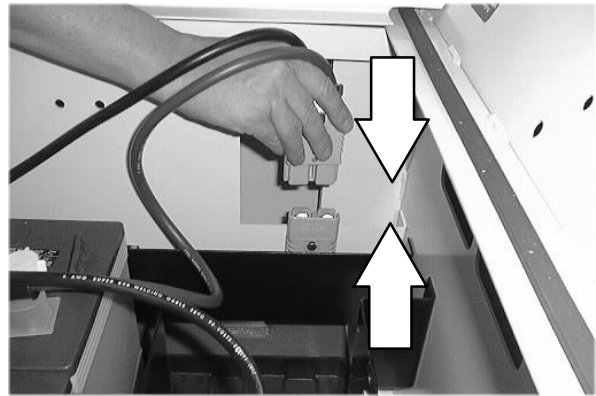

HYDROLINK® BATTERY WATERING SYSTEM (OPTION)

The following instructions are for models equipped with the HydroLINK battery watering system option.

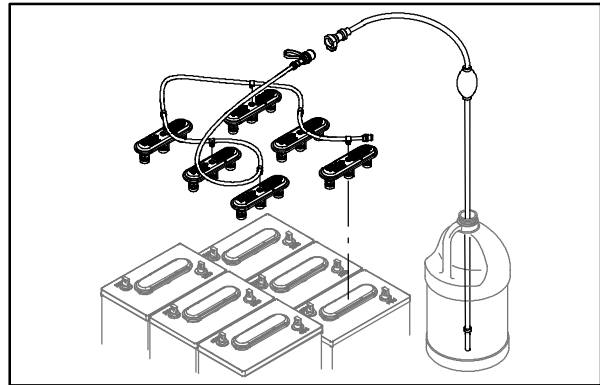

The optional HydroLINK battery watering system provides a safe and easy way to maintain the proper electrolyte levels in your batteries. It is designed exclusively for Trojan® wet/lead-acid batteries.

Check the battery watering system hoses and connections for damage or wear after every 100 hours.

FOR SAFETY: Before leaving or servicing machine, stop on level surface, turn off machine, and remove key.

1. Lift the operator seat open and engage the seat support.
2. Fully charge batteries prior to using the battery watering system. Do not add water to batteries before charging, the electrolyte level will expand and may overflow when charging. See *CHARGING THE BATTERIES*

3. After charging batteries, check the battery electrolyte level indicators located on the battery covers. If the level indicator is white add water as described in the following instructions. If the level indicators are black the electrolyte is at the correct level, no water is required.



4. Locate the battery fill hose coupler inside the battery compartment. Remove the dust cap and connect the hand pump hose.

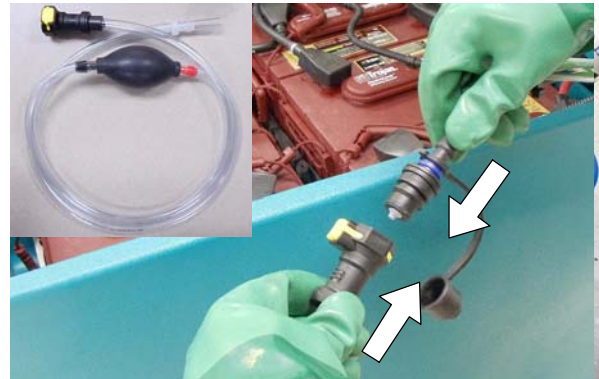

5. Submerge the other end of the hand pump hose into a bottle of distilled water.



6. Squeeze the bulb on the hand pump hose until firm. The level indicators will turn black when full.

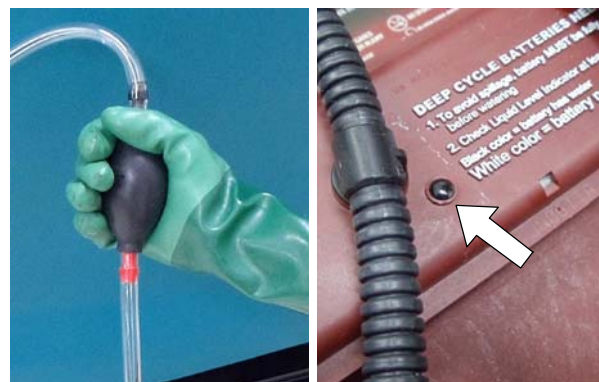

7. After adding water, replace the dust cap on the battery fill hose and store the hand pump hose inside the machine's battery compartment for future use.

BELTS AND CHAINS

VACUUM FAN BELT

Check the vacuum fan belt tension and wear after every 100 hours of operation.

The correct tension is when the belt deflects 12.7 mm (0.50 in) from a force of 17 kg (38 lb) at belt midpoint.

FOR SAFETY: When servicing machine, avoid moving parts. Do not wear loose jackets, shirts or sleeves when working on machine.

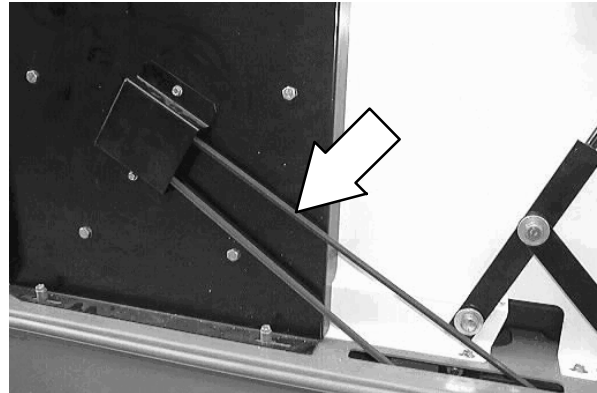

MAIN BRUSH BELT

The main brush belt drives the main brush. Check the main brush belt for wear and tension after every 100 hours of operation.

Set the tension with the top sheave. The correct tension on the belt is when the top sheave is putting 6 kg (14 lb.) of pressure on the main brush belt.

FOR SAFETY: When servicing machine, avoid moving parts. Do not wear loose jackets, shirts or sleeves when working on machine.

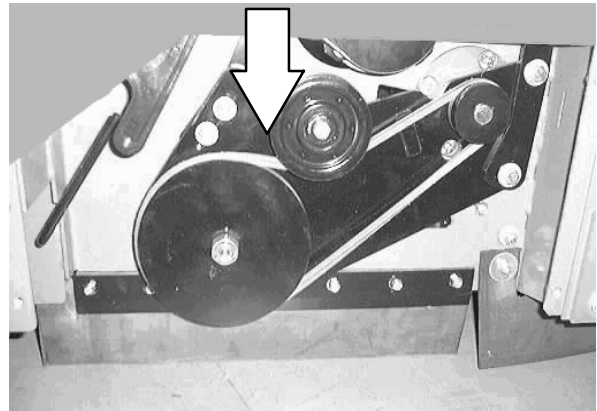

STEERING GEAR CHAIN

The steering chain turns the front wheel as the steering wheel is turned to steer the machine. Lubricate the steering chain with SAE 30- weight engine oil after every 200 hours of operation.

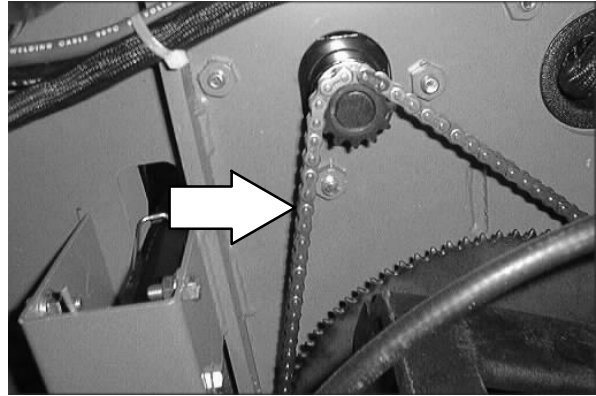
**STATIC DRAG CHAIN**

The static drag chain prevents the buildup of static electricity in the machine. The chain is attached to the machine by a rear main brush skirt retaining bolt.

Make sure the chain is touching the floor at all times.

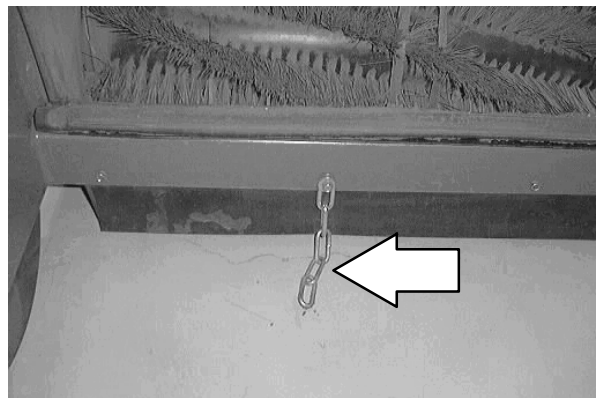

DEBRIS HOPPER

HOPPER DUST FILTER

The hopper filter filters the air pulled up from the hopper. The dust filter is equipped with a shaker to remove the accumulated dust particles. The dust filter shaker is operated by the vacuum fan and filter shaker switch.

Shake the dust filter before emptying the hopper and at the end of every work shift. Check and clean or replace the dust filter after every 100 hours of operation.

To clean the dust filter, use one of the following methods:

- **SHAKING** - Press and hold the main brush, vacuum and filter shaker switch to the **Filter shaker** position.
- **TAPPING** - Remove the filter and tap the filter gently on a flat surface with the dirty side down. Do not damage the edges of the filter element and seals, or the filter will not seat properly in the filter frame.
- **AIR** - Always wear eye protection when using compressed air. Blow air through the dust filter opposite the direction of the arrows. Never use more than 690 kPa (100 psi) of air pressure and never closer than 50 mm (2 in) away from the filter. This may be done with the dust filter in the machine.

FOR SAFETY: When servicing machine, wear eye and ear protection if using pressurized air or water.



REMOVING HOPPER DUST FILTER

1. Stop the machine, set the parking brake and turn the machine power off.

FOR SAFETY: Before leaving or servicing machine, stop on level surface, set parking brake, turn off machine, and remove key.

2. Unlatch and remove hopper cover.

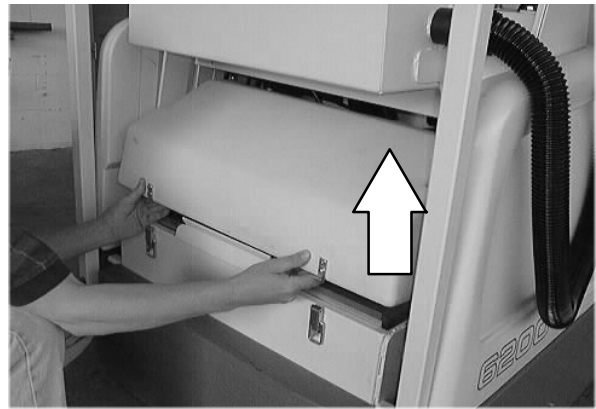

3. Unplug the filter shaker from the main harness.

Note: Carefully pull the wires apart from the bodies of the plugs Do not unplug the connections from the shaking mechanism. Do not pull on the wires. Damage could occur to the wires or the shaking mechanism.

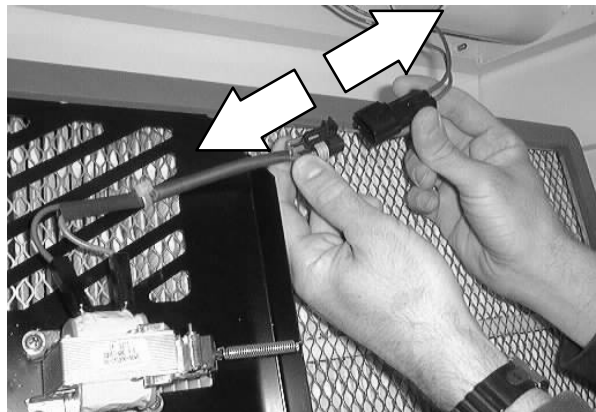

4. Lift dust filter element out of hopper.

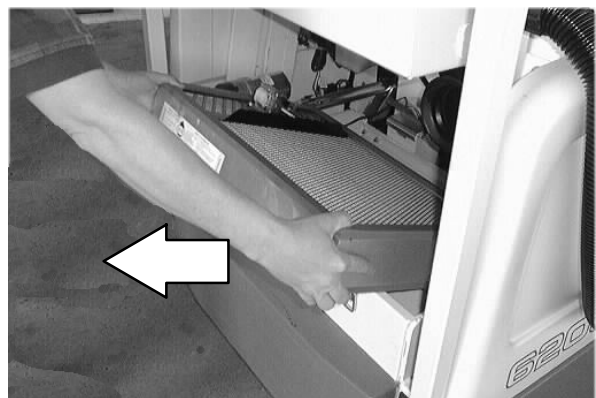

MAINTENANCE

5. Lift the VCS system filter shaker off of the filter.

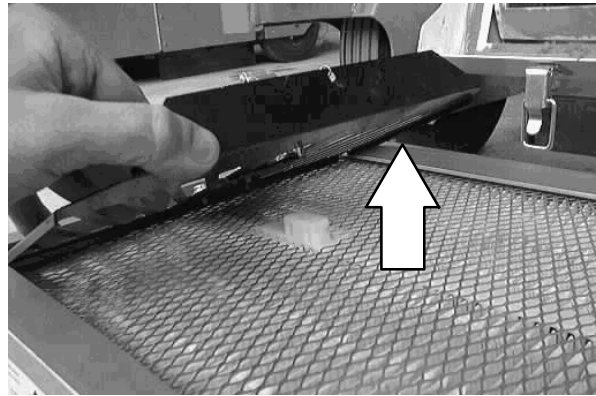

6. Clean or discard the Instant Access filter as required.

7. Place the VCS system filter shaker onto the new or cleaned filter. Use care to insert the shaking pin into the filter comb correctly.

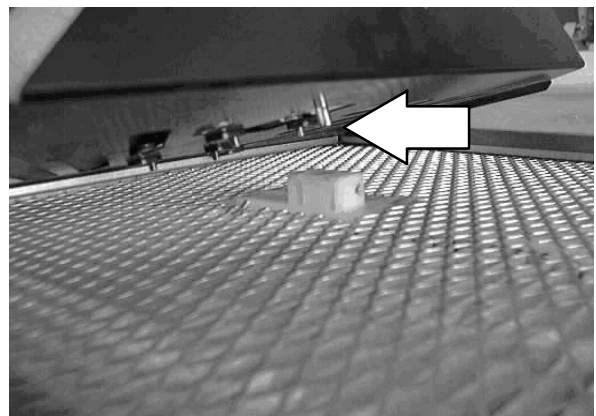

8. Place the edges of the shaker firmly between the filter and the filter seal.

NOTE: When installed properly, the shaker plate cannot move in either front-to-back or side-to-side directions. If the shaker is loose, it will not function properly.

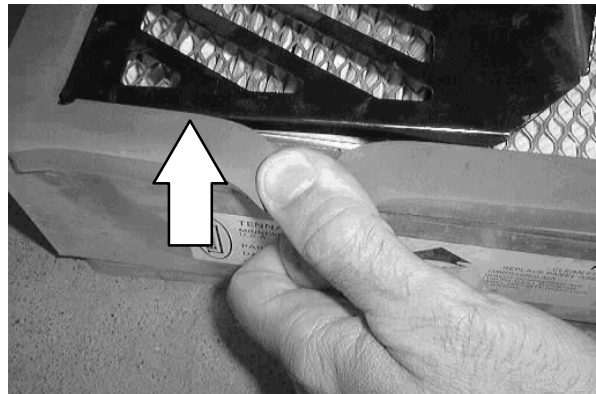

9. The filter shaker should lay flat against the filter. Check to make sure the comb tab is not caught below the filter shaker plate.

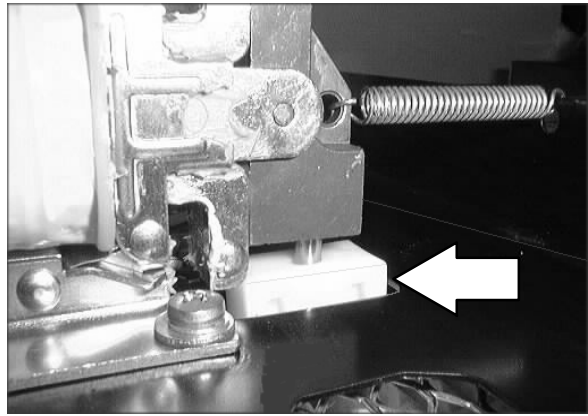

10. Check the shaker solenoid gap with the end of the shipping tab. The gap should be the same width as the tab. If it is not, loosen the mounting screws, adjust the gap by repositioning the shaker solenoid, then retighten the screws.

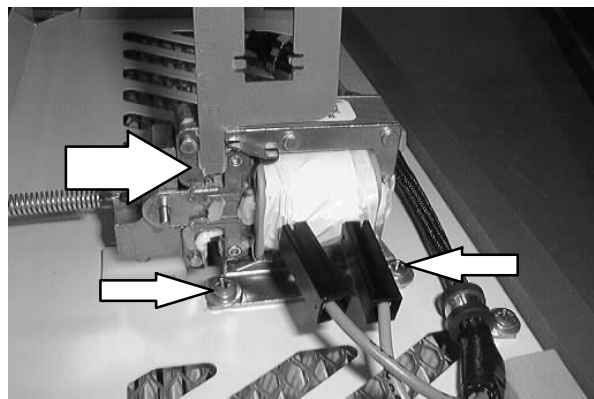

11. Return the filter back into the machine.

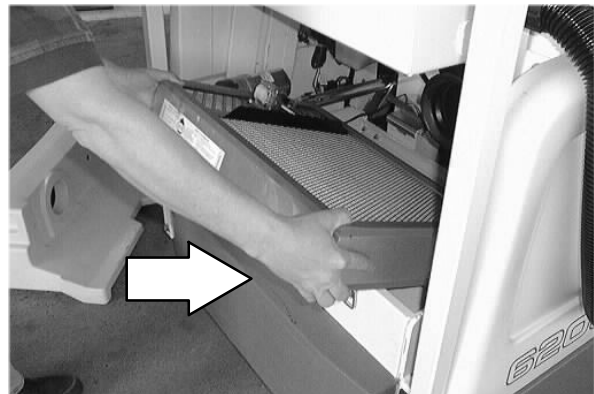

MAINTENANCE

12. Reconnect the main harness to the shaker mechanism.

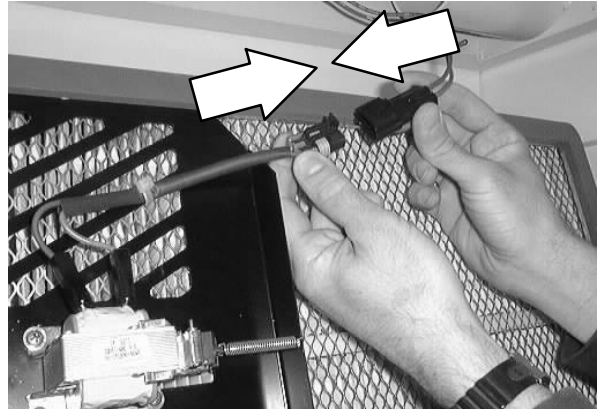

13. Check the dust filter seals.

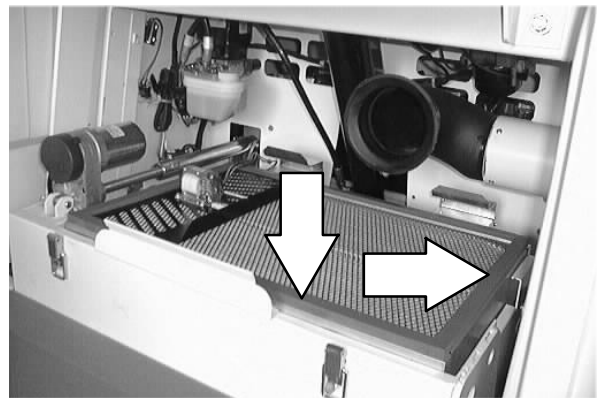

14. Replace hopper cover and secure with latches.

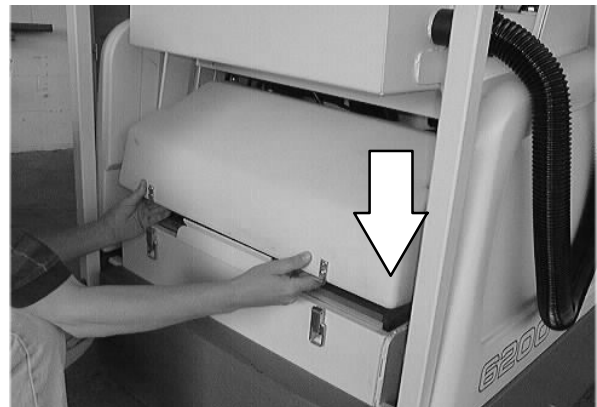

THERMO SENTRY

The Thermo Sentry is located in the vacuum fan inlet duct.

If a fire ignites in the hopper, the Thermo Sentry will shut off the vacuum fan. If this occurs, drive the machine to a safe location, open the hopper and eliminate the source of heat. Turn the machine off and back on to reset the Thermo Sentry.



BRUSHES

MAIN BRUSH

The main brush is cylindrical and spans the width of the machine, sweeping debris into the hopper.

Check the brush daily for wear or damage. Remove any string or wire tangled on the main brush, main brush drive hub, or main brush idler hub.

Check the main brush pattern weekly. The pattern should be 50 to 75 mm (2 to 3 in) wide with the main brush in the lowered position.

Rotate the main brush end-for-end after every 50 hours of operation for maximum brush life and best sweeping performance.

Replace the main brush when it no longer cleans effectively.

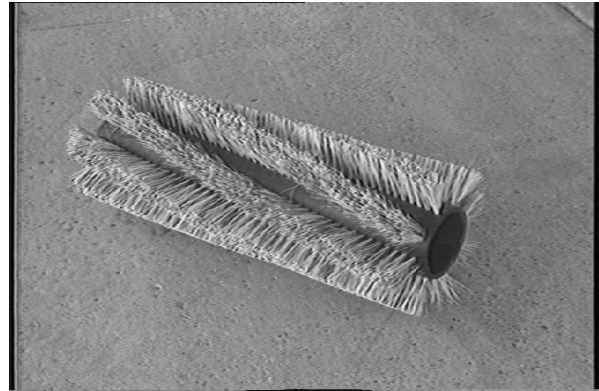

REPLACING MAIN BRUSH

1. Stop the machine, set the parking brake and turn the machine power off.

FOR SAFETY: Before leaving or servicing machine, stop on level surface, set parking brake, turn off machine, and remove key.

2. Open the left side main brush access door.

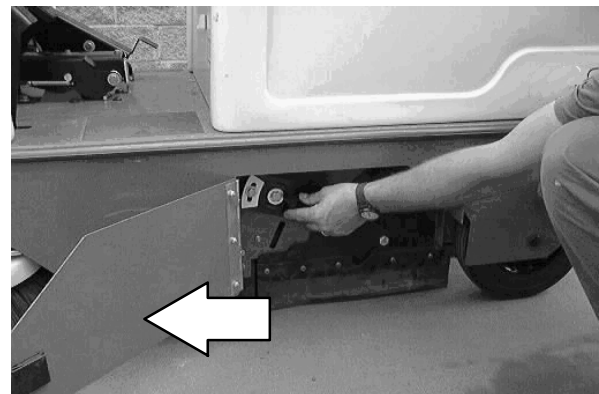

3. Loosen the idler arm mounting knob and three other side skirt mounting knobs. Remove the brush idler arm assembly.

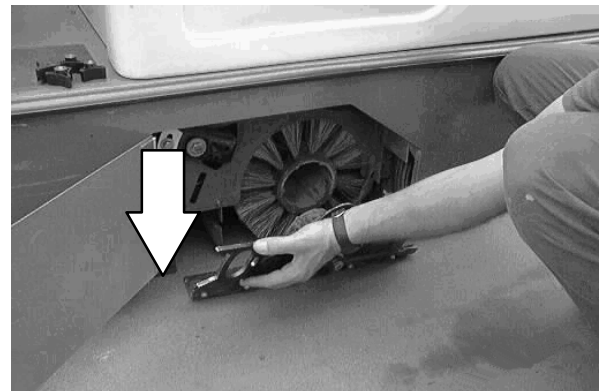

MAINTENANCE

4. Grasp the main brush; pull it off the brush drive plug and out of the main brush compartment.
5. Put the new or rotated end-for-end main brush on the floor next to the access door.
6. Slide the main brush onto the drive plug. Rotate the brush until it engages the drive plug, and push it all the way onto the plug.



7. Check that the recirculation skirt is tucked in behind the frame.
8. Slide the main brush idler arm plug onto the main brush.

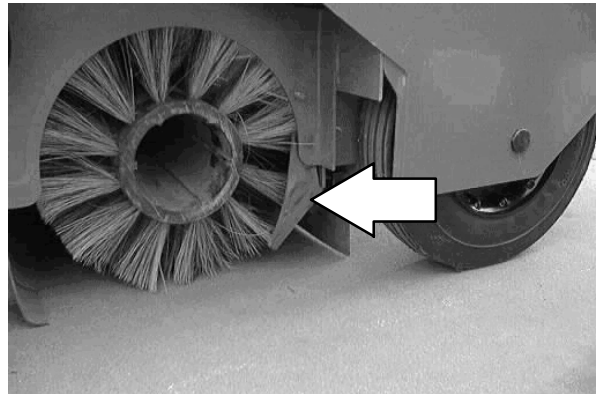

9. Secure the idler arm on the bolts. Hand tighten the mounting knobs.
10. Close the main brush access door.

CHECKING AND ADJUSTING MAIN BRUSH PATTERN

1. Apply chalk, or some other material that will not blow away easily, to a smooth, level floor.
2. Raise the side brush and main brush and position the main brush over the chalked area.
3. Start and lower the main brush for 15 to 20 seconds while keeping a foot on the brakes to keep the machine from moving.

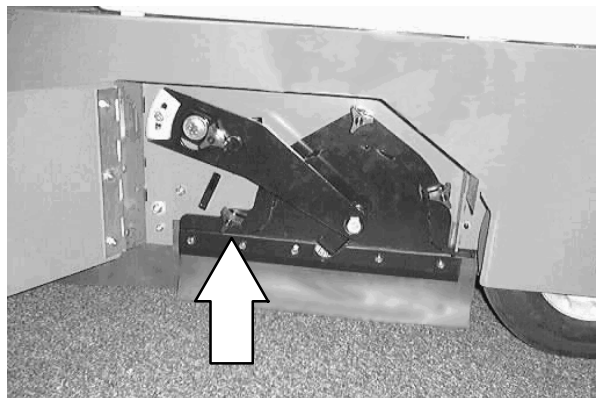

NOTE: If chalk or other material is not available, allow the brushes to spin on the floor for two minutes. A polish mark will remain on the floor.

4. Raise the main brush.
5. Drive the machine off the test area.

6. Observe the width of the brush pattern. The proper brush pattern width is 50 to 75 mm (2 to 3 in).

The brush taper is factory set and should not need adjustment unless parts of the brush system have been replaced.

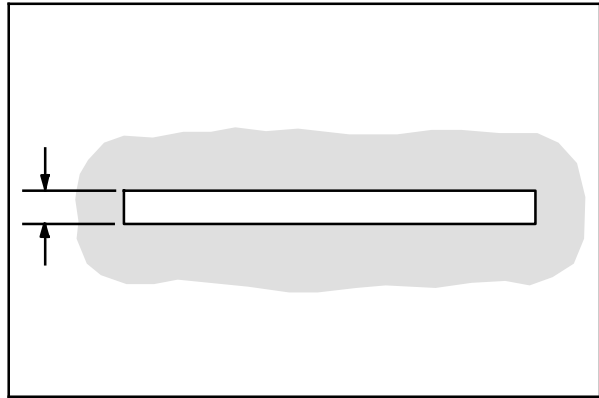

00582

If the main brush pattern is tapered, more than 15 mm (0.5 in) on one end than the other, adjust the taper as follows:

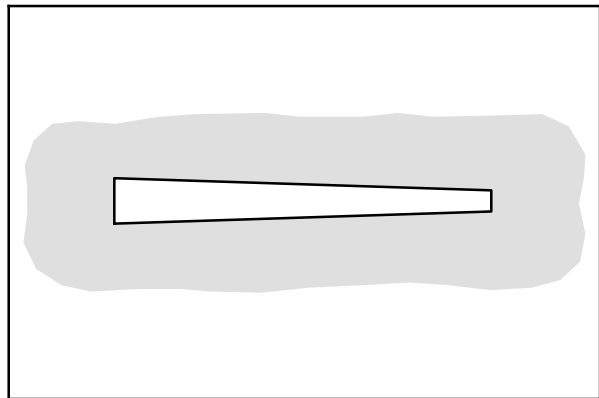

00601

- A. Loosen the brush shaft bearing bracket mounting bolt and the idler arm securing head.
- B. Allow the brush to operate and float into position for approximately 30 seconds.
- C. Tighten the adjustment bolt and idler arm securing knob.
- D. Check the main brush pattern and readjust as necessary.

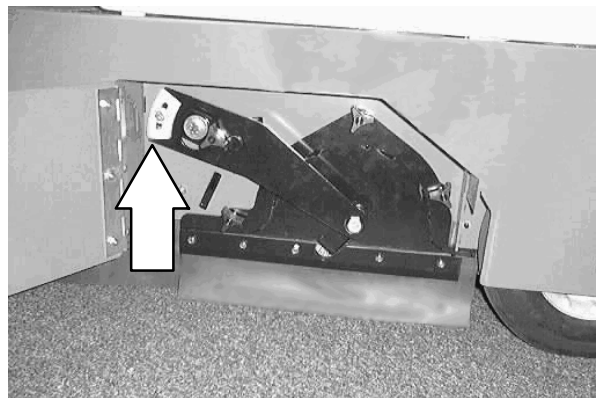

MAINTENANCE

SIDE BRUSH

The side brush sweeps debris along edges into the path of the main brush.

Check the brush daily for wear or damage. Remove any string or wire found tangled on the side brush or side brush drive hub.

Check the side brush pattern daily. The side brush bristles should contact the floor in a 10 o'clock to 3 o'clock pattern when the brush is in motion.

Replace the brush(es) when it no longer cleans effectively.

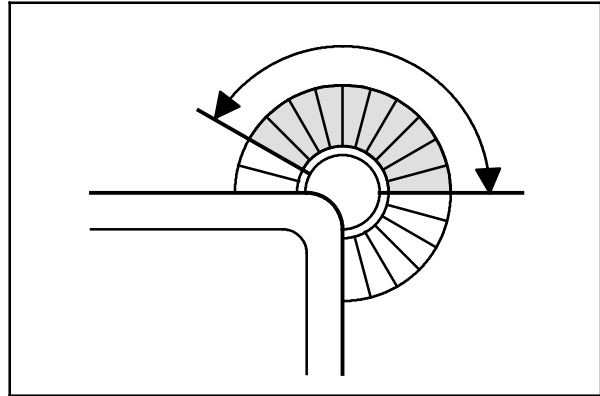

350327

Adjust the side brush pattern by loosening the hex screw located above the side brush pulley. Move the pulley mount bracket up or down to achieve the proper side brush pattern. Retighten the hex screw.

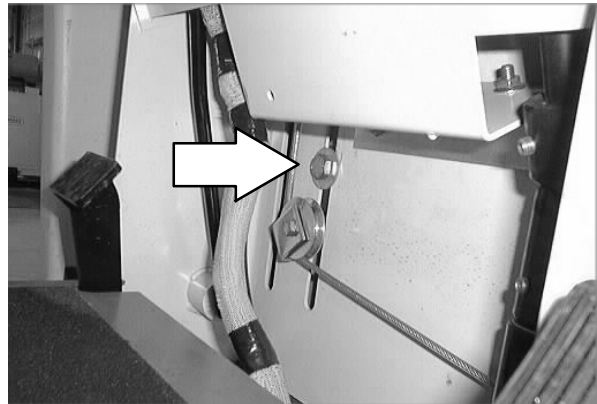

REPLACING SIDE BRUSH

1. Stop the machine, set the parking brake and turn the machine power off.

FOR SAFETY: Before leaving or servicing machine, stop on level surface, set parking brake, turn off machine, and remove key.

2. Remove the side brush retaining pin from under the side brush drive shaft by pulling the pin keeper off over the end of the pin.
3. Slide the side brush off the side brush drive shaft.
4. Slide the new side brush onto the side brush drive shaft.
5. Insert the side brush retaining pin through the side brush hub and shaft.
6. Secure the pin by clipping the pin keeper over the end of the pin.

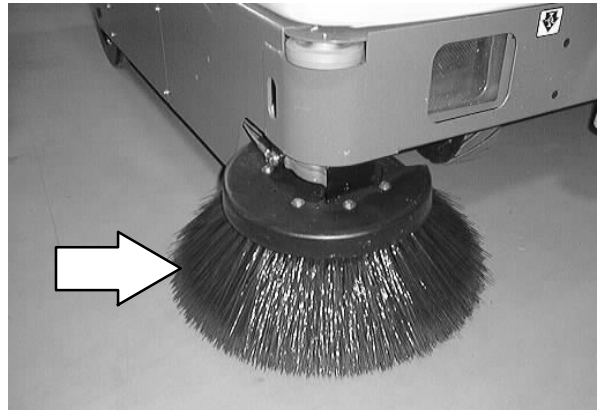

SIDE BRUSH GUARD

Check the side brush guard for damage or wear every 200 hours of operation. Replace the guard when it becomes worn.

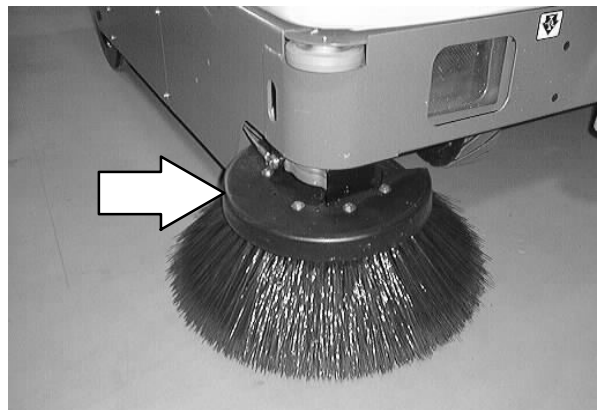

SKIRTS AND SEALS

SIDE SKIRTS

The side skirts are located on both sides of the machine in front of the main brush compartment. The side skirts should clear the floor up to 5 mm.

Check the skirts for damage, wear and adjustment daily.

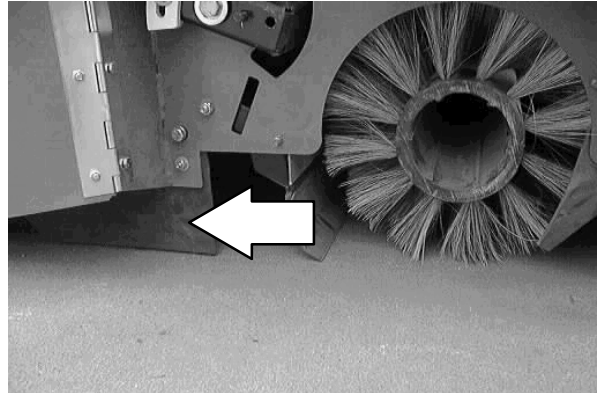

LARGE DEBRIS TRAP SKIRT

The large debris trap skirt is located along the front of the main brush. This skirt is raised and lowered by the large debris trap pedal, allowing larger debris to be trapped and swept up into the hopper.

Check the skirt for damage and wear daily.

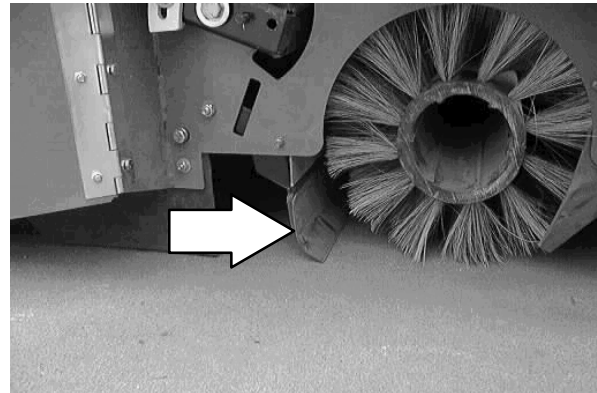

SIDE RECIRCULATION SKIRTS

The side recirculation skirts are located on both sides of the main brush compartment. The side recirculation skirts should clear the floor up to 5 mm.

Check the skirts for damage, wear and adjustment daily.

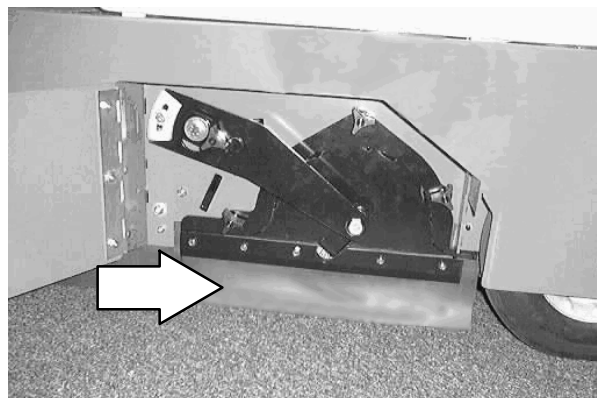

REAR SKIRTS

The two rear skirts are located on the bottom rear of the main brush compartment. The vertical skirt should clear the floor up to 5 mm. The rear recirculation skirt requires no adjustment.

Check the skirts for damage, wear and adjustment daily.

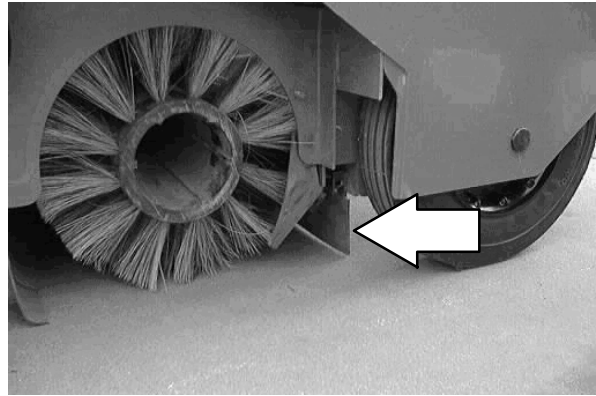

NOTE: The rear recirculation skirt must be folded in between the brush and the machine frame before the brush door is mounted for the machine to work properly.

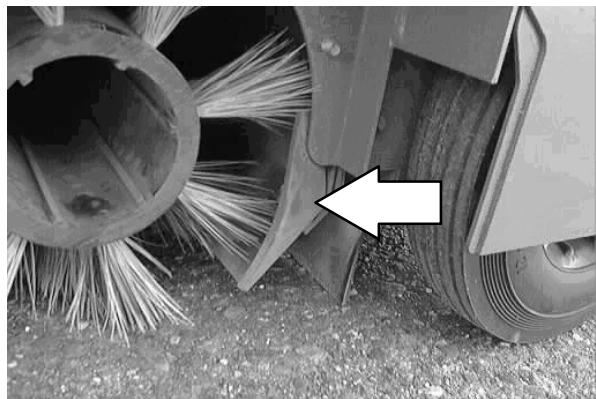
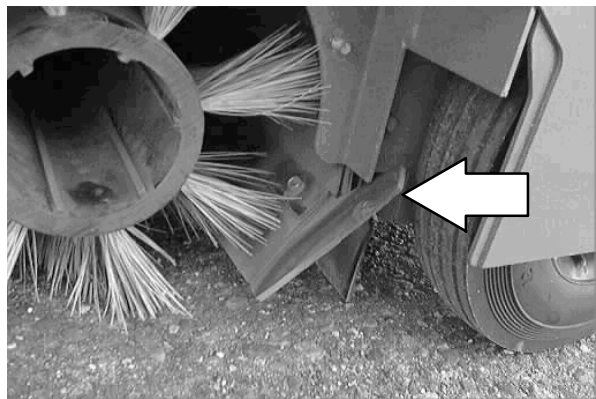

MAINTENANCE

HOPPER SEALS

The hopper seals are located around the edge of the opening between the main brush and the hopper. The hopper rests against the seals when the hopper is in the closed position.

Check the seals for wear or damage after every 100 hours of operation.

 **WARNING: Raised hopper may fall.**
Engage hopper support bar.

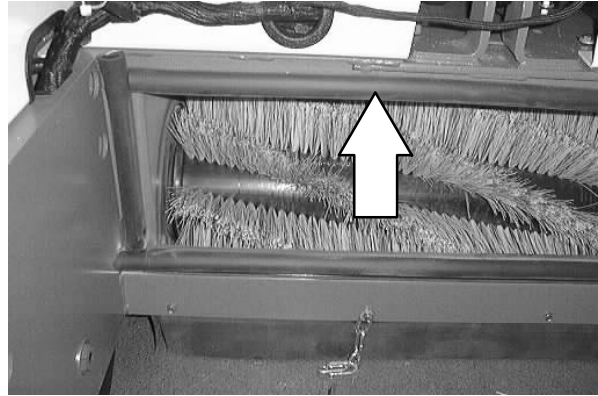

HOPPER DOOR SEAL

The hopper door seal is located on the bottom of the hopper and seals the hopper door when the hopper door is closed.

Check the seal for wear or damage after every 100 hours of operation.

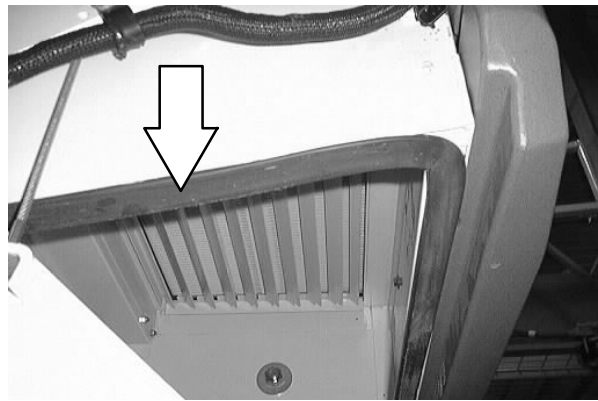

HOPPER LIP SEAL

The hopper lip seal is located on the inside of the rear lip of the hopper door and seals the inside lip of the hopper door with the hopper.

Check the seal for wear or damage after every 100 hours of operation.

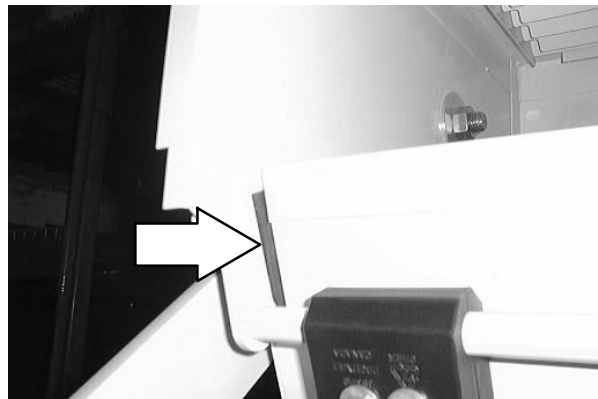

VACUUM SEAL

The vacuum seal is located behind the debris hopper and seals with the hopper filter cover when the hopper is in the lowered position.

Check the seal for wear or damage after every 100 hours of operation.

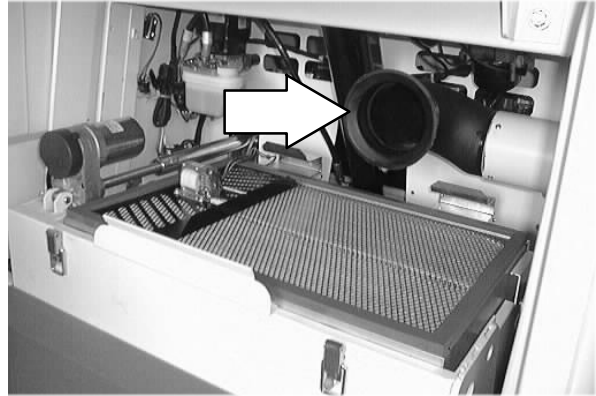
**HOPPER FILTER SEALS**

The hopper filter seals are located along the outside edge of the top and the bottom of the hopper filter. The hopper filter seals seal the hopper filter in between the hopper baffle plate and the hopper filter cover when the hopper filter cover is latched down in the proper operating position.

Check the seals for wear or damage after every 100 hours of operation.

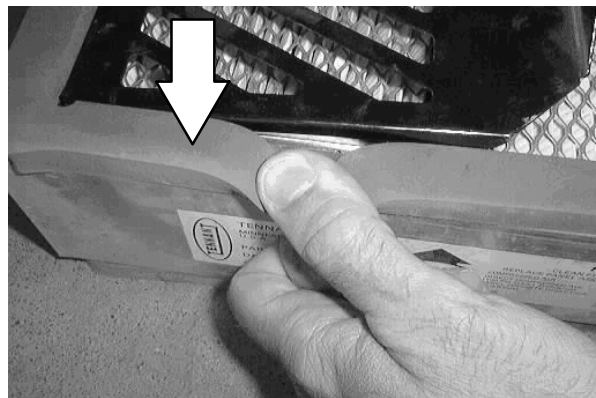

BRAKES AND TIRES

BRAKES

The mechanical brake is located on the front wheel. The brake is operated by the brake foot pedal, connecting rods and cable.

Check the brake adjustment after every 200 hours of operation. If the brake does not respond well to pressure on the brake pedal, you may need to adjust the brake.

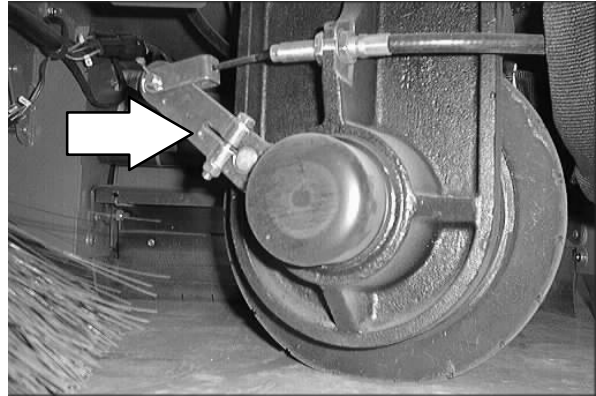

Adjust brake cable tension with cable nuts and brake lever.

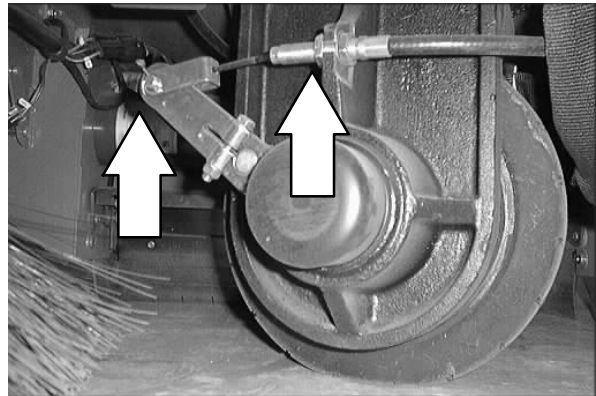

TIRES

The tires on the machine are solid. Check the tires after every 100 hours of operation for damage.

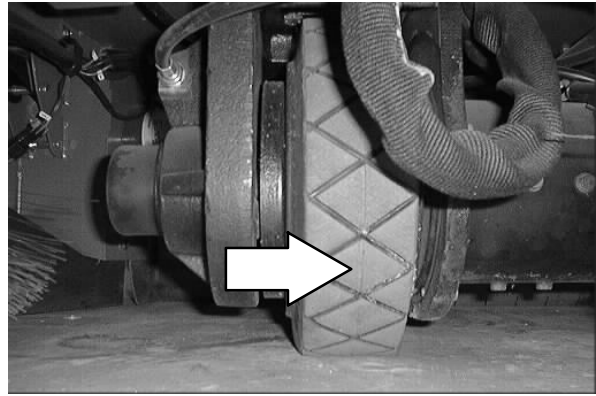

Check the torque on the rear wheel axles every 800 hours of operation. The proper torque on rear wheel axle is 22.4- 28 Nm (16- 20 ft lbs).

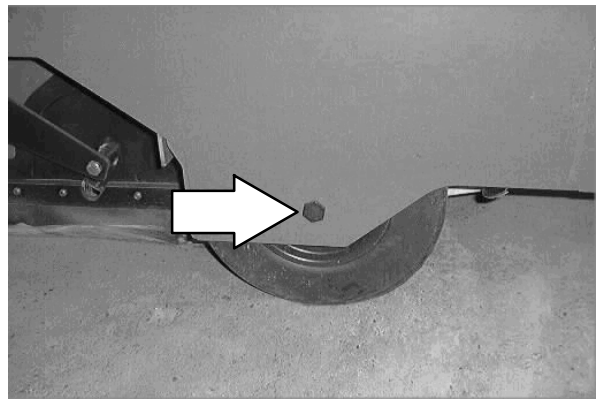

ELECTRIC MOTORS

The carbon brushes on the propelling, vacuum fan, and brush motors should be inspected every 800 hours of operation.

PUSHING, TOWING, AND TRANSPORTING THE MACHINE

PUSHING OR TOWING THE MACHINE

If the machine becomes disabled, it can be pushed or towed from the front or rear, but it is easier and more stable to tow from the front end.

Only push or tow the machine for a *very short distance* and do not exceed 3.2 kp/h (2 mph). It is NOT intended to be pushed or towed for a long distance or at a high speed.

ATTENTION! Do not push or tow machine for a long distance or damage may occur to the propelling system.

TRANSPORTING THE MACHINE

1. Position the front of the machine at the loading edge of the truck or trailer.

FOR SAFETY: Use truck or trailer that will support the weight of the machine.

NOTE: Empty the hopper before transporting the machine.

2. If the loading surface is not horizontal or is higher than 380 mm (15 in) from the ground, use a winch to load machine.

If the loading surface is horizontal AND is 380 mm (15 in) or less from the ground, the machine may be driven onto the truck or trailer.

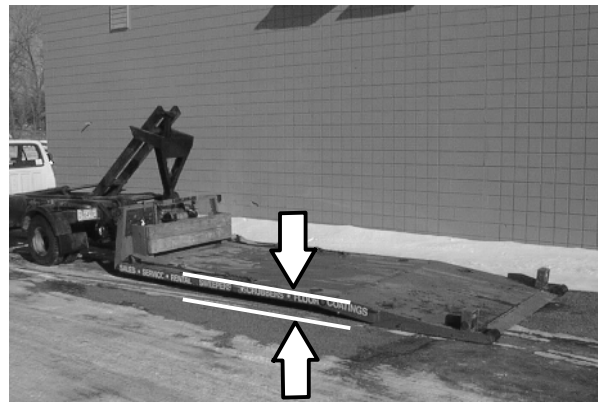

3. To winch the machine onto the truck or trailer, attach the winching chains to the front tie down located in the front of the machine frame.

FOR SAFETY: When loading machine onto truck or trailer, use winch. Do not drive the machine onto the truck or trailer unless the loading surface is horizontal AND is 380 mm (15 in) or less from the ground.

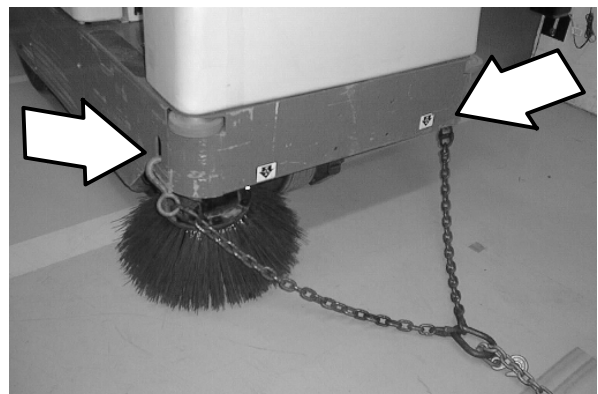

4. Position the machine onto the truck or trailer as far as possible. If the machine starts to veer off the centerline of the truck or trailer, stop and turn the steering wheel to center the machine.
5. Set the parking brake and block the machine tires. Tie down the machine to the truck or trailer before transporting.

The front tie-down locations are the holes in the front of the machine frame.



The rear tie-down locations are the holes in the sides of the machine frame near the rear bumper.

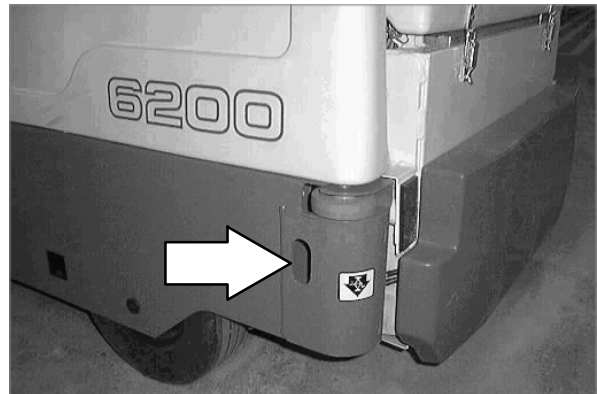

6. If the loading surface is not horizontal or is higher than 380 mm (15 in) from the ground, use a winch to unload machine.

If the loading surface is horizontal AND is 380 mm (15 in) or less from the ground, the machine may be driven off the truck or trailer.

FOR SAFETY: When unloading machine off truck or trailer, use winch. Do not drive the machine off the truck or trailer unless the loading surface is horizontal AND 380 mm (15 in) or less from the ground.

MACHINE JACKING

Empty the hopper before jacking the machine. You can jack up the machine for service at the designated locations. Use a hoist or jack that will support the weight of the machine. Always stop the machine on a flat, level surface and block the tires before jacking up the machine.

FOR SAFETY: Before leaving or servicing machine, stop on level surface, set parking brake, turn off machine, and remove key.

The front jacking locations are on the flat bottom edge of the front of the machine frame.

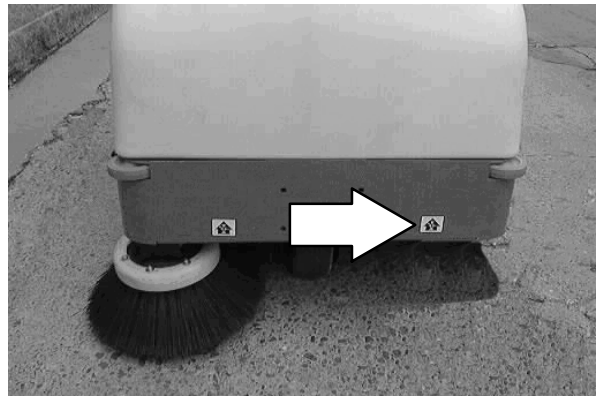

The rear jacking locations are on the corners of the rear frame.

FOR SAFETY: When servicing machine, block machine tires before jacking up machine.

FOR SAFETY: When servicing machine, jack up machine at designated locations only. Block machine up with jack stands.

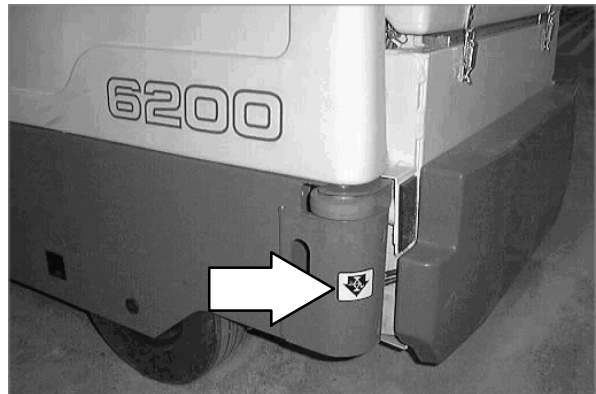

STORING MACHINE

The following steps should be taken when storing the machine for extended periods of time.

1. Charge the batteries before storing machine to prolong the life of the batteries.

ATTENTION: Do not expose machine to rain, store indoors.

NOTE: To prevent potential machine damage store machine in a rodent and insect free environment.

SPECIFICATIONS

GENERAL MACHINE DIMENSIONS/CAPACITIES

| Item | Dimension/capacity | |
|---|----------------------|-------------|
| Length | 1955 mm | (77 in) |
| Width | 1070 mm | (43 in) |
| Width w/side brush | 1117 mm | (44 in) |
| Height | 1435 mm | (56.5 in) |
| Height with overhead guard | 2045 mm | (80.5 in) |
| Track | 94 mm | (37 in) |
| Wheelbase | 97 mm | (38 in) |
| Main sweeping brush diameter | 203 mm | (8 in) |
| Main sweeping brush length | 710 mm | (28 in) |
| Side brush diameter | 520 mm | (20.5 in) |
| Sweeping path width | 710 mm | (28 in) |
| Sweeping path width with one side brush | 1070 mm | (42 in) |
| Sweeping path width with two side brushes | 1397 mm | (55 in) |
| Main sweeping brush pattern width | 65 mm | (2.5 in) |
| Hopper weight capacity | 135 kg | (300 lb) |
| Hopper volume capacity | 125 L | (4.4 cu ft) |
| Dust filter area | 4.5 sq m | (49 sq ft) |
| GVWR | 923 kg | (2035 lb) |
| Ceiling height minimum dumping clearance | 2286 mm | (90 in) |
| Vibration level at steering wheel does not exceed | 2.5 m/s ² | |
| Vibration level at operator seat does not exceed | 0.5 m/s ² | |

GENERAL MACHINE PERFORMANCE

| Item | Measure | |
|---|-----------|-----------|
| Maximum forward speed | 10.0 km/h | (6 mph) |
| Maximum reverse speed | 4.8 km/h | (3 mph) |
| Minimum aisle turn | 2095 mm | (82.5 in) |
| Minimum turning radius, left | 1400 mm | (55 in) |
| Minimum turning radius, right | 1400 mm | (55 in) |
| Maximum rated incline with empty hopper | 10°/18% | |
| Maximum rated incline with full hopper | 6°/11% | |

SPECIFICATIONS

POWER TYPE

| Type | Quantity | Volts | Ah Rating | Weight |
|-----------|----------|-------|---------------|-----------------|
| Batteries | 6 | 6 | 220 @ hr rate | 177 kg (390lbs) |
| | 6 | 6 | 235 @ hr rate | 177 kg (390lbs) |
| | 6 | 6 | 335 @ hr rate | 310 kg (625lbs) |

| Type | Use | VDC | Kw (hp) |
|-----------------|--------------------|-----|------------------|
| Electric Motors | Propelling | 36 | 1.1 Kw (1.5 hp) |
| | Scrub brush (main) | 36 | 0.67 Kw (0.9 hp) |
| | Vacuum fan | 36 | 0.6 Kw (0.75 hp) |

| Type | VDC | A | Hz | Phase | VAC |
|---------|-----|----|----|-------|-----|
| Charger | 36 | 20 | 60 | 1 | 240 |

STEERING

| Type | Power source | Emergency steering |
|--------------------------------|-----------------|--------------------|
| Front wheel, manual controlled | Manual steering | Manual |

HYDRAULIC SYSTEM

| System | Capacity | Fluid Type |
|---------------------|-----------------|-----------------------------------|
| Hydraulic reservoir | .53 L (.14 gal) | ISO Grade 32 - below 7° C (45° F) |
| Hydraulic total | 1.4 L (.37 gal) | |

BRAKING SYSTEM (For machines serial number 003467 and below)

| Type | Operation |
|----------------|--|
| Service brakes | Mechanical disc brake (1), one front wheel, cable actuated |
| Parking brake | Utilizes service brakes, cable actuated |

TIRES

| Location | Type | Size |
|-----------|-------|---------------------------------|
| Front (1) | Solid | 101 x 305 mm (4 in x12 in OD) |
| Rear (2) | Solid | 90 x 305 mm (3.5 in x 12 in OD) |

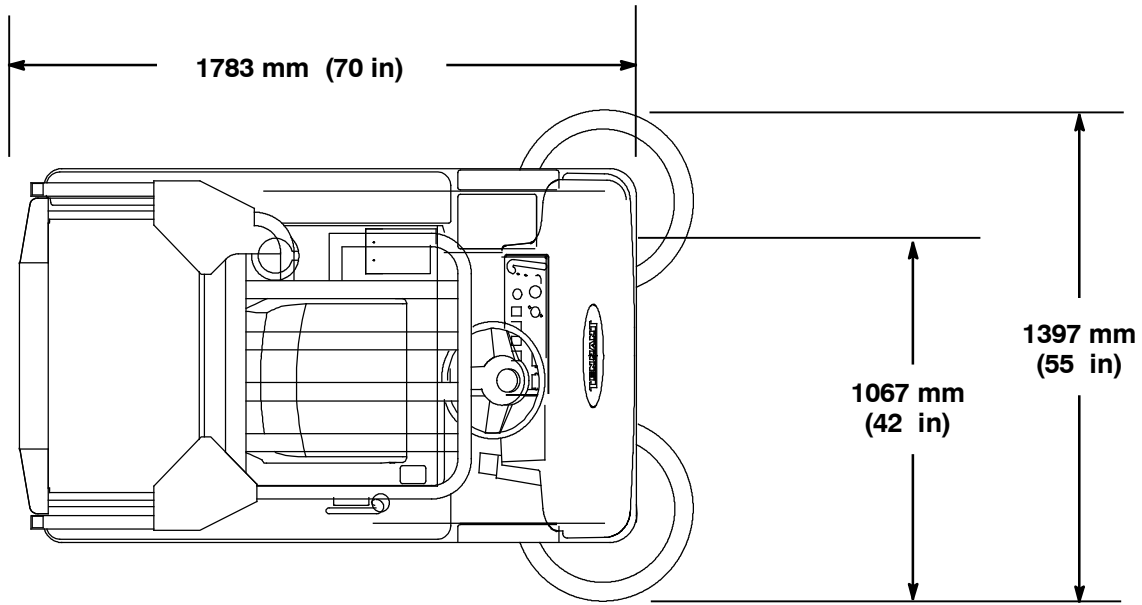

TOP VIEW

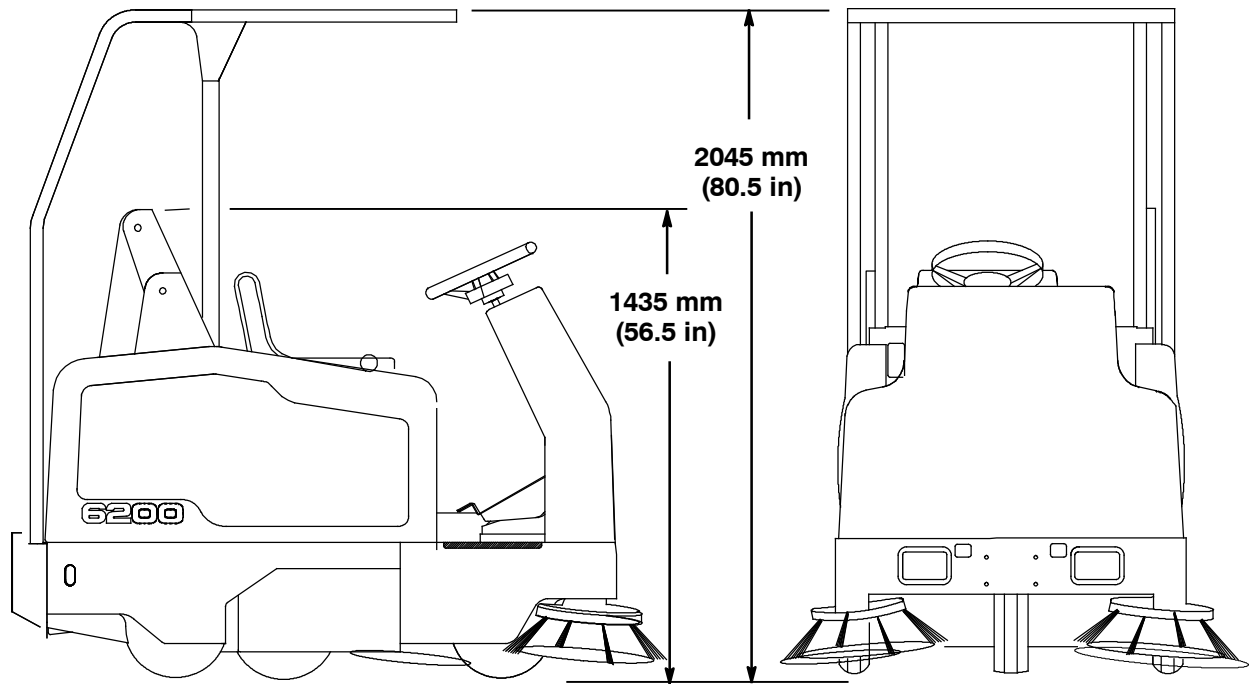

SIDE VIEW

FRONT VIEW

MACHINE DIMENSIONS

352945

A

Adjustable operator seat, 17
Aisle turn, 75

B

Batteries, 49 - 53
 Charger specifications, 76
 Charging, 50 - 53
 Checking connections / cleaning, 50
 Checking the electrolyte level, 49
 Discharge indicator, 13
 Hydrolink Battery Watering System (option), 52
 Maintenance, 50
 Rollout Battery Option, 38
 Specifications, 76

Battery, Fluid level, 19, 29

Battery discharge indicator, 13

Belts, 54

 Main brush, 54
 Vacuum Fan, 54

Brake pedal, 11

Brakes, 19, 29, 70

 System specifications, 76

Brushes, 21 - 24, 61 - 66

 Adjusting main brush taper, 63
 Checking main brush pattern, 62 - 64
 Checking side brush pattern, 64
 Main brush, 21, 61 - 64
 Main brush bristle length, 61
 Main brush lever, 12
 Maintenance, 19, 29
 Pattern adjustment, 19, 29
 Rear skirts, 67
 Replacing main brush, 61 - 63
 Replacing side brush, 65
 Side brush, 22, 64 - 66
 Side brush bristle length, 64
 Side brush lever, 14

Button, Horn, 14

C

Capacities, 75

Chain, Steering gear, 46, 55

Chains, 54

 Static drag, 55

Circuit breakers, 16

Cleaning carpet, 21

Control panel

 Battery discharge indicator, 13
 Hourmeter, 13

Controls, 9

 Battery discharge indicator, 13

 Brake pedal, 11

 Circuit breakers, 16

 Deluxe suspension seat, 17

 Directional pedal, 10

 Fuse, 16

 Hopper door switch, 15

 Hopper Switch, 15

 Horn button, 14

 Hourmeter, 13

 Large debris trap pedal, 11

 Main brush lever, 12

 On off key switch, 14

 Operating lights switch, 14

 Operating/hazard lights switch, 15

 Operation, 10

 Parking brake (For machines serial number
 003468 and above), 11

 Parking brake pedal (For machines below serial
 number 003468), 11

 Power kill switch, 12

 Side brush lever, 14

 Steering wheel, 13

 Symbols, 8 - 10

 Vacuum fan and filter shaker switch, 12

D

Debris hopper, 56 - 58

Deluxe suspension seat, 17

Dimensions, 75

Directional pedal, 10

Dust filter, 56

 Cleaning, 56

E

Electric motors, 71, 76

Electrical

 Batteries, 49 - 53

 Charging batteries, 50 - 53

 Circuit breakers, 16

 Fuse, 16

 On off key switch, 14

Electrical system, Batteries

 Checking connections / cleaning, 50

 Checking the electrolyte level, 49

Emptying the hopper, 26 - 29

F

Fuses, 16

H

Hopper
 Cleaning dust filter, 56
 Debris, 56 - 58
 Emptying the hopper, 26 - 29
 Switch, 15

Hopper
 Door switch, 15
 Support bar, 18

Hopper door seal, 68

Hopper door switch, 15

Hopper dust filter, 56

Hopper filter, Removal, 57

Hopper filter seals, 69

Hopper lip seal, 68

Hopper seals, 68

Hopper support bar, 18, 30
 Disengaging, 32
 Engaging, 30

Hopper switch, 15

Horn button, 14

Hourmeter, 13

How the machine works, 19

Hydraulic fluid, 48

Hydraulic fluid reservoir, 47

Hydraulic hoses, 48

Hydraulic system, Specifications, 76

Hydraulics, 47 - 49
 Fluid, 48 - 50
 Fluid level, 19, 29, 47
 Hoses, 48
 Reservoir, 47

Hydrolink Battery Watering System (option), 52

J

Jack points, 74

Jacking up the machine, 74

L

Large debris trap pedal, 11

Large debris trap skirt, 66

Levers
 Main brush, 12
 Side brush, 14

Lights
 Operating lights switch, 14
 Operating/hazard lights switch, 15

Lubrication, 46 - 48

Lubrication , Steering castor pivot bearing, 46

M

Machine, Troubleshooting, 43

Machine components, 7

Machine dimensions, 77

Machine jacking, 74

Machine tie down location, 73

Main brush, 21, 61 - 64
 Adjust brush taper, 63
 Belt, 54
 Bristle length, 61
 Checking brush pattern, 62 - 64
 Maintenance, 61
 Natural fiber, 21
 Rear skirts, 67
 Replacing, 61 - 63

Main brush belt, 54

Main brush lever, 12

Maintenance, 44
 Axle torque, Rear wheel, 71
 Batteries, 49
 Checking connections / cleaning, 50
 Checking the electrolyte level, 49
 Intervals, 44 - 46
 Recommended, 6

Maintenance chart, 44 - 46

Motors, Electric, 71, 76

N

Natural fiber main brush, 21

O

On - off key switch, 14

Operating lights switch, 14

Operating/hazard lights switch, 15

Operation on inclines, 33

Operator Responsibility, 6

Operator Seat, 17

Option, Deluxe suspension seat, Adjustment, 17

Options, 34 - 36
Adjustable operator seat, 17
Operating lights switch, 14
Operating/hazard lights switch, 15
QuickMop, 36
Rollout Battery, 38
Vacuum Wand, 34

P

Parking brake (For machines serial number 003468 and above), 11
Parking brake pedal (For machines below serial number 003468), 11
Pedal, Directional, 10
Pedals
Brake, 11
Large debris trap pedal, 11
Parking brake (For machines below serial number 003468), 11
Post operation checklist, 29
Power kill switch, 12
Pre operation checklist, 19
Pushing machine, 72
Pushing or towing the machine, 72
Pushing, towing, and transporting machine, 72

Q

QuickMop Option, 36

R

Rear skirts, 67
Rear wheel axle torque, 71
Recirculation skirt, Tucking in skirt, 67
Removing hopper filter, 57
Rollout Battery Option, 38

S

Operation, 6
QuickMop, 36
Rollout Battery, 38
Vacuum Wand, 34

Safety
Labels, 5
Precautions, 3 - 5

Seals, 66 - 69
Hopper, 68
Hopper door, 68
Hopper filter, 69
Hopper lip, 68
Vacuum, 69

Seat
Adjustable operator, 17
Deluxe suspension, 17
Operator, 17

Service records, 19, 29

Side brush, 22, 64 - 66
Bristle length, 64
Checking brush pattern, 64
Lever, 14
Replacing, 65

Side brush guard, 65

Side brush lever, 14

Side recirculation skirts, 66

Side skirts, 66

Skirts, 66 - 69
Large debris trap, Seals, 66
Rear, 67
Side, 66
Side recirculation, 66

Skirts and seals, 19, 29

Specifications, 75 - 78
Braking system, 76
Chargers, 76
Electric motors, 76
Hydraulic system, 76
Machine capacities, 75
Machine dimensions, 75
Machine performance, 75
Power type, 76
Steering, 76
Tires, 76

Starting the machine, 20

Static drag chain, 55

Steering, 19, 29
Specifications, 76

Steering castor pivot bearing, 46
Steering gear chain, 46, 55
Steering wheel, 13
Stop sweeping, 25
Stopping the machine, 28
Storing machine, 74
Sweeping, 23
Sweeping and brush information, 21 - 24
Switches
 Hopper door, 15
 Hopper switch, 15
 On off key, 14
 Operating lights, 14
 Operating/hazard lights, 15
 Power kill, 12
 Vacuum fan and filter shaker, 12

T

Thermo Sentry, 60
Tie down location, 73
Tires, 70, 71
 Specifications, 76
Towing machine, 72
Transporting machine, 72
Transporting the machine, 72
Travel speed, 75
Troubleshooting, 43

V

Vacuum fan, Belt, 54
Vacuum fan and filter shaker switch, 12
Vacuum fan belt, 54
Vacuum seal, 69
Vacuum Wand Option, 34

